

# Understanding Construction Drawings

7th Edition



Mark W. Huth

# UNDERSTANDING CONSTRUCTION DRAWINGS

Mark W. Huth





# UNDERSTANDING CONSTRUCTION DRAWINGS

Mark W. Huth



Australia • Brazil • Japan • Korea • Mexico • Singapore • Spain • United Kingdom • United States

This is an electronic version of the print textbook. Due to electronic rights restrictions, some third party content may be suppressed. Editorial review has deemed that any suppressed content does not materially affect the overall learning experience. The publisher reserves the right to remove content from this title at any time if subsequent rights restrictions require it. For valuable information on pricing, previous editions, changes to current editions, and alternate formats, please visit [www.cengage.com/highered](http://www.cengage.com/highered) to search by ISBN#, author, title, or keyword for materials in your areas of interest.

Important Notice: Media content referenced within the product description or the product text may not be available in the eBook version.

**Understanding Construction Drawings,  
Seventh Edition**

**Mark W. Huth**

SVP, GM Skills & Global Product Management:  
Jonathan Lau

Product Director: Matt Seeley

Senior Product Manager: Vanessa Myers

Executive Director, Development:  
Marah Bellegarde

Senior Content Development Manager:  
Larry Main

Content Developer:  
Katie Ostler, Lumina Datamatics

Product Assistant: Jason Koumourdias

Vice President, Strategic Marketing Services:  
Jennifer Ann Baker

Marketing Manager: Scott Chrysler

Senior Content Project Manager:  
Kara A. DiCaterino

Senior Digital Project Manager: Amanda Ryan

Designer: Angela Sheehan

Cover Designer: Joe Devine

Cover & Interior Design Image(s):  
Hitdelight/Shutterstock.com  
istock.com/suprun

Additional Interior Design Image(s):  
BorisShevchuk/Shutterstock.com  
Bloomicon/Shutterstock.com

© 2019, 2014 Cengage Learning

WCN: 02-300

ALL RIGHTS RESERVED. No part of this work covered by the copyright herein may be reproduced or distributed in any form or by any means, except as permitted by U.S. copyright law, without the prior written permission of the copyright owner.

For product information and technology assistance, contact us at  
**Cengage Learning Customer & Sales Support, 1-800-354-9706**

For permission to use material from this text or product,  
submit all requests online at **www.cengage.com/permissions**.

Further permissions questions can be e-mailed to  
**permissionrequest@cengage.com**

Library of Congress Control Number: 2017950099

Book Only ISBN: 978-1-337-40864-6

Package ISBN: 978-1-337-40863-9

**Cengage Learning**

20 Channel Center Street  
Boston, MA 02210  
USA

Cengage Learning is a leading provider of customized learning solutions with employees residing in nearly 40 different countries and sales in more than 125 countries around the world. Find your local representative at **www.cengage.com**.

Cengage Learning products are represented in Canada by Nelson Education, Ltd.

To learn more about Cengage Learning, visit **www.cengage.com**  
Purchase any of our products at your local college store or at our preferred online store **www.cengagebrain.com**

**Notice to the Reader**

Publisher does not warrant or guarantee any of the products described herein or perform any independent analysis in connection with any of the product information contained herein. Publisher does not assume, and expressly disclaims, any obligation to obtain and include information other than that provided to it by the manufacturer. The reader is expressly warned to consider and adopt all safety precautions that might be indicated by the activities described herein and to avoid all potential hazards. By following the instructions contained herein, the reader willingly assumes all risks in connection with such instructions. The publisher makes no representations or warranties of any kind, including but not limited to, the warranties of fitness for particular purpose or merchantability, nor are any such representations implied with respect to the material set forth herein, and the publisher takes no responsibility with respect to such material. The publisher shall not be liable for any special, consequential, or exemplary damages resulting, in whole or part, from the readers' use of, or reliance upon, this material.



# Contents

<b>Preface</b> .....	vii
<b>Part 1 DRAWINGS: TWO-UNIT APARTMENT</b>	
<b>Unit 1</b> The Design-Construction Sequence and the Design Professions .....	2
<b>Unit 2</b> Views .....	8
<b>Unit 3</b> Scales .....	15
<b>Unit 4</b> Alphabet of Lines .....	19
<b>Unit 5</b> Use of Symbols .....	25
<b>Unit 6</b> Plan Views .....	35
<b>Unit 7</b> Elevations .....	41
<b>Unit 8</b> Sections and Detail .....	47
<b>Part 1 Test</b> .....	55
<b>Part 2 READING DRAWINGS: LAKE HOUSE</b>	
<b>Unit 9</b> Clearing and Rough Grading the Site .....	60
<b>Unit 10</b> Locating the Building .....	65
<b>Unit 11</b> Site Utilities .....	71
<b>Unit 12</b> Footings .....	76
<b>Unit 13</b> Foundation Walls .....	84
<b>Unit 14</b> Drainage, Insulation, and Concrete Slabs .....	90
<b>Unit 15</b> Framing Systems .....	95
<b>Unit 16</b> Columns, Piers, and Girders .....	109
<b>Unit 17</b> Floor Framing .....	116
<b>Unit 18</b> Laying Out Walls and Partitions .....	128
<b>Unit 19</b> Framing Openings in Walls .....	133
<b>Unit 20</b> Roof Construction Terms .....	140
<b>Unit 21</b> Roof Trusses .....	144
<b>Unit 22</b> Common Rafters .....	155
<b>Unit 23</b> Hip and Valley Framing .....	162
<b>Unit 24</b> Cornices .....	171
<b>Unit 25</b> Windows and Doors .....	180
<b>Unit 26</b> Exterior Wall Coverings .....	188
<b>Unit 27</b> Decks .....	197
<b>Unit 28</b> Finishing Site Work .....	202



<b>Unit 29</b>	Fireplaces .....	211
<b>Unit 30</b>	Stairs .....	219
<b>Unit 31</b>	Insulation and Room Finishing .....	224
<b>Unit 32</b>	Cabinets .....	236
<b>Unit 33</b>	Lake House Specifications .....	240
	<b>Part 2 Test</b> .....	<b>249</b>

### Part 3 **MULTIFAMILY CONSTRUCTION: URBAN COURTS**

<b>Unit 34</b>	Orienting the Drawings .....	252
<b>Unit 35</b>	Fire-Rated and Acoustical Considerations .....	262
<b>Unit 36</b>	Seismic Considerations .....	269
	<b>Part 3 Test</b> .....	<b>279</b>

### Part 4 **HEAVY COMMERCIAL CONSTRUCTION: SCHOOL ADDITION**

<b>Unit 37</b>	Heavy Commercial Construction .....	283
<b>Unit 38</b>	Coordination of Drawings .....	296
<b>Unit 39</b>	Structural Drawings .....	304
<b>Unit 40</b>	HVAC & Plumbing Drawings .....	312
<b>Unit 41</b>	Electrical Drawings .....	324
	<b>Part 4 Test</b> .....	<b>344</b>

## **APPENDICES**

Appendix A	School Addition Master Keynotes .....	347
Appendix B	Math Reviews .....	357
Appendix C	Material Symbols in Sections .....	373
Appendix D	Plumbing Symbols .....	374
Appendix E	Electrical Symbols .....	375
Appendix F	Common Abbreviations .....	376

## **GLOSSARY** **378**

## **INDEX** **383**

### **DRAWING PACKET**

Two-Unit Apartment Building Drawings

Lake House Drawings

Urban Courts Drawings

School Addition Drawings



# Preface

## Intended Audience

*Understanding Construction Drawings* is designed for students in construction programs in two- and four-year colleges and technical institutes, as well as apprentice training. Designed for a course in print reading focused on both residential and commercial construction, the book helps you learn to read the drawings that are used to communicate information about buildings. It includes drawings for buildings that were designed for construction in several parts of North America. The diversity of building classifications and geographic locations ensures that you are ready to work on construction jobs anywhere in the industry. Everyone who works in building construction should be able to read and understand the drawings of the major trades.

## How to Use This Book

The book is divided into four major parts and several units within each part. Each part relates to the prints in the separate drawing packet:

- **Part 1, Drawings: Two-Unit Apartment**, introduces you to the basics of print reading by covering views, scales, lines, and symbols, as well as the various plan views, elevations, and sections and details.
- **Part 2, Reading Drawings: Lake House**, provides information on how to interpret drawings for project specifics—everything from footings and foundation walls to room finishing and cabinets.
- **Part 3, Multifamily Construction: Urban Courts**, details more advanced residential print reading and applies the skills learned in Parts 1 and 2 to other types of construction, as well as mechanical and electrical trades.
- **Part 4, Heavy Commercial Construction: School Addition**, presents the need-to-know information on interpreting prints for large commercial

construction including structural drawings, mechanical drawings, and electrical drawings.

## Features of the Units

The individual units are made up of four elements: Objectives, the main body of the unit, Using What You Learned, and Assignment.

- The **Objectives** appear at the beginning of the unit so that you will know what to look for as you study the unit.
- The **main body** is the presentation of content with many illustrations and references to the prints for the building being studied in that part.
- **Using What You Learned** gives you an opportunity to do a practice exercise that is similar to the exercises found in the assignment questions for that unit. The real-world need to be able to do the exercise is explained first. The exercise is presented and followed by a detailed explanation of how to find the specified information. **Each unit contains 10 to 20 Assignment** questions that require you to both understand the content of the unit and apply that understanding to reading the drawings. There are more than 600 questions in all.

The book is divided into four parts, corresponding with the four buildings. At the end of each part there is a test. Additionally units include one or more **Green Notes**, which provide insights and suggestions for green home construction.

## The Drawing Packet, Glossary, and Appendix

At the back of the text you will find several helpful aids for studying construction drawings.

- The **drawing packet** that is conveniently packaged with the book contains 22 sheets with separate

drawings that relate to each of the parts within the book. The drawing packet contains prints for four buildings: a simple two-family duplex that is very easy to understand, a more complex single-family home, one building in an urban development located in an earthquake zone, and an addition to a school.

- The **Glossary** defines all the new technical terms introduced throughout the textbook. Each of these terms is defined where it is first used, but if you need to refresh your memory, turn to the Glossary.
- The **Math Reviews** in Appendix B are an innovative feature that has helped many construction students through a difficult area. These are concise reviews of the basic math you are likely to encounter throughout the building construction field. As math is required in this textbook, reference is made to the appropriate Math Review. All the math skills needed to complete the end-of-unit assignments in this book are covered in the Math Reviews.
- The **Appendix** also includes a complete list of construction abbreviations commonly used on prints, along with their meaning. There is also a section that explains the most commonly used symbols for materials and small equipment.

## New to This Edition

*Understanding Construction Drawings*, Seventh Edition, represents a major revision of the book. Part 3 is all new, based on a 4-story residential building in an area known to have high seismic activity. One of the new units is entirely devoted to the special considerations that are encountered in areas with seismic activity.

## MindTap For Understanding Construction Drawings, 7e

NEW! The MindTap for Understanding Construction Drawings, 7th Edition features an integrated course offering a complete digital experience for the student and teacher. This MindTap is highly customizable and combines assignments, videos, interactivities, and quizzing along with the enhanced ebook to enable students to directly analyze and apply what

they are learning and allow teachers to measure skills and outcomes with ease.

- A Guide: Relevant interactivities combined with prescribed readings, featured multimedia, and quizzing to evaluate progress, will guide students from basic knowledge and comprehension to analysis and application.
- Personalized Teaching: Teachers are able to control course content—hiding, rearranging existing content, or adding and creating own content to meet the needs of their specific program.
- Promote Better Outcomes: Through relevant and engaging content, assignments and activities, students are able to build the confidence they need to ultimately lead them to success. Likewise, teachers are able to view analytics and reports that provide a snapshot of class progress, time in course, engagement and completion rates.

## Supplements to the Text

Along with the *Understanding Construction Drawings, Seventh Edition* book, we are proud to offer supplemental offerings that will help support classroom instruction and engage students in learning.

The **Instructor Resources** available on our Companion website contains *free* helpful tools for the instructor teaching a course on reading and interpreting construction drawings. Each component follows the chapters in the book and is intended to help instructors prepare classroom presentations and student evaluations. To access these helpful tools, please visit [www.cengagebrain.com](http://www.cengagebrain.com). At the home page, search for this Companion website by typing in the ISBN of the book in the search box at the top of the page. On the page illustrating this book, click on the “Access” button next to “Free Study Tools” and this will direct you to the following resources:

- An **Instructor’s Guide** provides answers to all the Assignment questions and test questions in the textbook, and explains how the answers were found or calculated. In addition, it contains more than

500 additional questions that can be used for tests, supplemental assignments, and review. The answer to each of these questions is given, along with an explanation of the answer.

- **PowerPoint Presentations** include an outline of each chapter along with photos and graphics to help illustrate important points and enhance classroom instruction. These presentations are editable, allowing instructors to include additional notes and photos/graphics from the Image Gallery included on our Companion website.
- **Cengage Learning Testing Powered by Cognero** is a flexible, online system that allows you to:
  - author, edit, and manage test bank content from multiple Cengage Learning solutions
  - create multiple test versions in an instant
  - deliver tests from your LMS, your classroom or wherever you want
- **Image Gallery** containing graphics and photos from all the chapters in the book provide an additional option for classroom presentations. Instructors may choose to add to the existing PowerPoint, or may wish to create their own presentations based on the book.

## Acknowledgments

I am grateful to all who contributed to this textbook. Special thanks are due to Ralph Henderson, School of Science and Technology, Rogue Community College for contributing most of the content of Unit 36 on seismic considerations.

The instructors and their students who have used the previous five editions have given me valuable feedback that has played an instrumental role in shaping this edition. Several companies provided expertise and contributed illustrations—including many of the figures that illustrate this book.

I would especially like to thank the architects and engineers who supplied the drawings for the drawing packet, namely:

Robert Kurzon

*Duplex and Lake House*

Carl Griffith

*Cataldo, Waters, and Griffith Architects, P.C., and HA2F Consultants in Engineering for the School Addition*

Chelsea Richardson and Shawn Sidener

*Jeffrey DeMure + Associates for architectural drawings of Urban Courts*

Karl Freeman

*O'Connor, Freeman, & Associates for structural drawings for Urban Courts*

Lastly, I would also like to thank the instructors who reviewed the manuscript for the previous editions and for this new edition. They have provided guidance in making it the best print reading textbook it could be.

Ralph Henderson

*Department Chair/Instructor for Construction Technology, Rogue Community College, Grants Pass, OR*

Steven Peterson

*Professor, Weber State University, Ogden, UT*

Scott Bretthauer

*Teacher, E.M.P.S., College of Lake County, Grayslake, IL*

Joe Dusek

*Professor, Construction Management Department, Triton College, River Grove, IL*

Judy Guentzler-Collins

*Building Technology Department, Cochise College, Sierra Vista, AZ*

Seongchan Kim

*Department of Engineering Technology, Western Illinois University, Macomb, IL*

## About the Author

The author of this textbook, Mark W. Huth, brings many years of experience in the industry to his writing—first as a carpenter and then as a contractor, building construction teacher, and construction publisher—his career has allowed him to consult with hundreds of construction educators in high schools, colleges, and universities. He has also authored several other successful construction titles, including *Basic Blueprint Reading for Construction*, *Residential Construction Academy: Basic Principles for Construction*, and *Practical Problems in Mathematics for Carpenters*.

# A Word about Math

Construction requires the use of mathematics. Whether you are a carpenter planning stairs, a plumber calculating pipe lengths and fitting allowances, or an estimator preparing for a contract bid, you need math to do your job. The math required in this textbook is basic, so you probably have learned enough math to do all of the work required. Most of the math required on a construction job can be done quite easily with a construction calculator, such as the one shown here. Today's construction calculators are preprogrammed to do everything from converting decimals to fractions, calculating the lengths of rafters, figuring cubic yards of concrete, and other standard industry computations.

If you are studying construction, you probably own a construction calculator now or will soon. However, as you progress in your learning and spend more time working on construction sites, you will soon find that you do not always have your trusty calculator handy. If you have learned to do the basic math required with a pencil and paper (or scrap of wood), you will not be hampered by not having your calculator. Also, it is easy to make big mistakes with a calculator—any kind of calculator. With one wrong press of a key, you can add when you meant to multiply or add an extra zero. If you

learn the math, you can check your work and ensure that it is close to what the calculator got, so there is less likely to be a catastrophic error.



A typical construction calculator.

For these reasons, you are urged to complete the assignments at the end of each textbook unit by doing the math *without a calculator*, at least until you feel confident in your ability. If you have trouble doing the math, check the Math Reviews in Appendix B at the back of the book. They give easy, step-by-step directions for doing all of the types of math needed in the book.



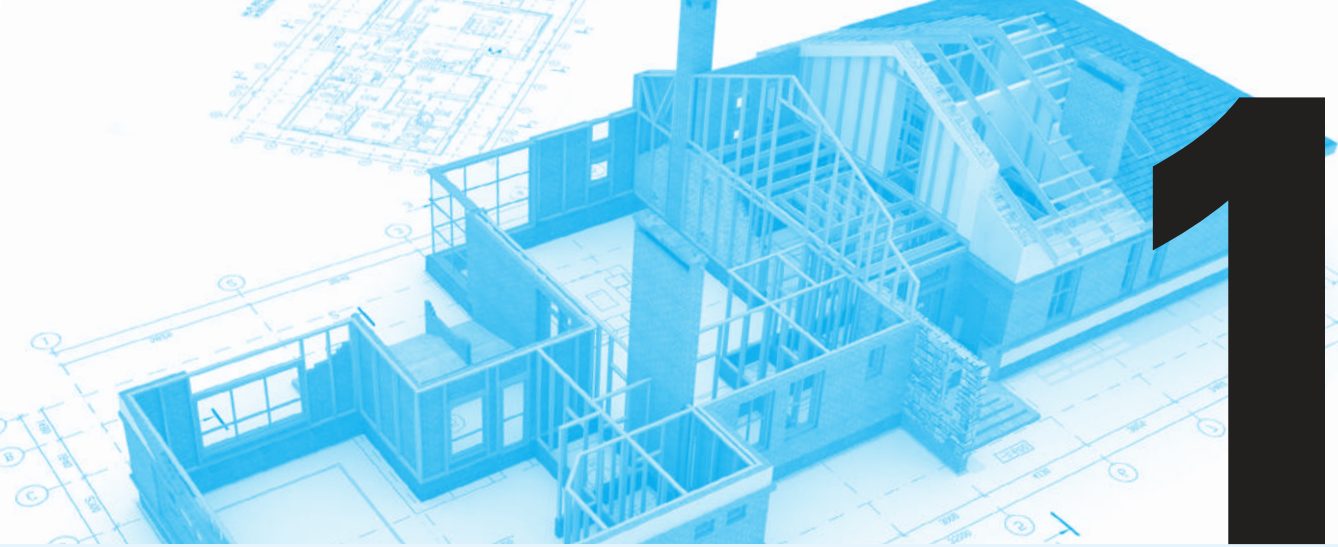

# PART

## DRAWINGS: TWO-UNIT APARTMENT

Part 1 helps you develop a foundation upon which to build skills and knowledge in reading the drawings used in the construction industry. The topics of the various units in this section are the basic concepts upon which all construction drawings are read and interpreted. The details of construction are explored in Parts 2, 3, and 4.

Many of the assignment questions in this part refer to the drawings of the Two-Unit Apartment Building (Duplex) included in the drawing packet that accompanies this textbook. The Duplex was designed as income property for a small investor. It was built on a corner lot in a small city in upstate New York. The Duplex is an easy-to-understand building. Its one-story, rectangular design requires only a minimum of views; you can quickly become familiar with the Duplex drawings.

# UNIT 1

## The Design-Construction Sequence and the Design Professions

### Objectives

After completing this unit, you will be able to perform the following tasks:

- Name the professions included in the design and planning of a house or light commercial building.
- List the major functions of each of these professions in the design and planning process.
- Identify the profession or agency that should be contacted for specific information about a building under construction.

The construction industry employs about 15 percent of the working people in the United States and Canada. A large portion of construction workers are involved in constructing new buildings, roads, airports, and industrial facilities. The rest are involved in repairing, remodeling, and maintenance. As the needs of our society change, the demand for different kinds of construction increases. Homeowners and businesses demand more energy-efficient buildings. The shift toward automation in business and industry means that new offices are needed. Our national centers of commerce and industry are shifting. These are only a few of the reasons that new housing starts are considered important indicators of our economic health.

The construction industry is made up of light construction (small buildings) and heavy construction (large buildings, roadways, bridges, industrial installations, etc.). The industry can also be divided into the following four classifications: residential, commercial, industrial, and civil. *Residential construction* includes single-family homes, small apartment buildings, and condominiums (see **Figure 1–1(a)**). *Commercial construction* includes



**Figure 1–1(a).** Single- and multi-family homes are classified as residential construction.



**Figure 1–1(b).** Commercial construction.



Courtesy of Bechtel Corporation. Photographer: Terry Lowenthal. Used by permission.

**Figure 1–1(c).** Industrial construction. Delta Energy Center, water treatment tanks and buildings in the foreground.

office buildings, hotels, stores, shopping centers, and other large buildings (see **Figure 1–1(b)**). *Industrial construction* includes structures other than buildings, such as refineries and paper mills, that are built for industry (see **Figure 1–1(c)**). *Civil construction* (see **Figure 1–1(d)**) is more closely linked with the land and refers to highways, bridges, airports, dams, and the like.

## The Design Process

The design process starts with the owner. The owner has definite ideas about what is needed, but may not be expert at describing that need or desire in terms the builder can understand. The owner contacts an architect to help plan the building.

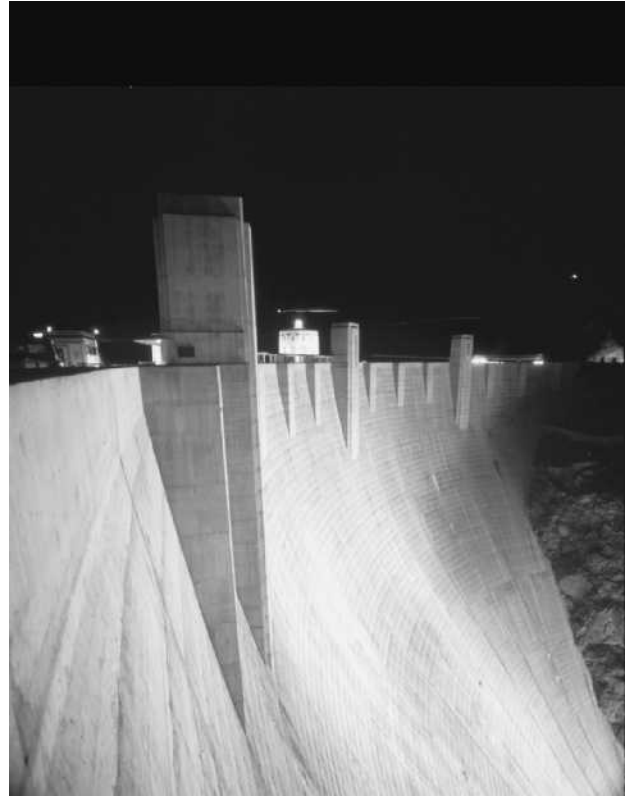

Courtesy of Bechtel Corporation. Photographer: Ray Frayne. Used by permission.

**Figure 1–1(d).** Civil construction. At 726 feet, Hoover Dam is the highest dam in the United States.



## GREEN NOTE

*Green construction can be defined in many different ways, and sometimes the definitions sound complicated. In its simplest terms, green construction is the process of designing and constructing a building that minimizes its impact on the environment both during construction, over its useful life, and, ultimately, the recyclability of its materials—or their safe and proper disposal—when that life comes to an end.*

*A green home is built from environmentally sustainable materials using practices that reduce material use and waste. A durable, long-lasting home has lower maintenance requirements and less overall impact on the environment than a home that needs to be replaced sooner or requires frequent repairs. A green home is also designed to conserve resources such as heating and cooling energy and water.*

The architect serves as the owner's agent throughout the design and construction process. Architects combine their knowledge of construction—of both the mechanics and the business—with artistic or aesthetic knowledge and ability. They design buildings for appearance and use.

The architect helps the owner determine how much space is needed, how many rooms are needed for now and

in the future, what type of building best suits the owner's lifestyle or business needs, and what the costs will be. As the owner's needs take shape, the architect makes rough sketches to describe the planned building. At first these may be balloon diagrams (see **Figure 1-2**) to show traffic flow and the number of rooms. Eventually, the design of the building begins to take shape (see **Figure 1-3**).

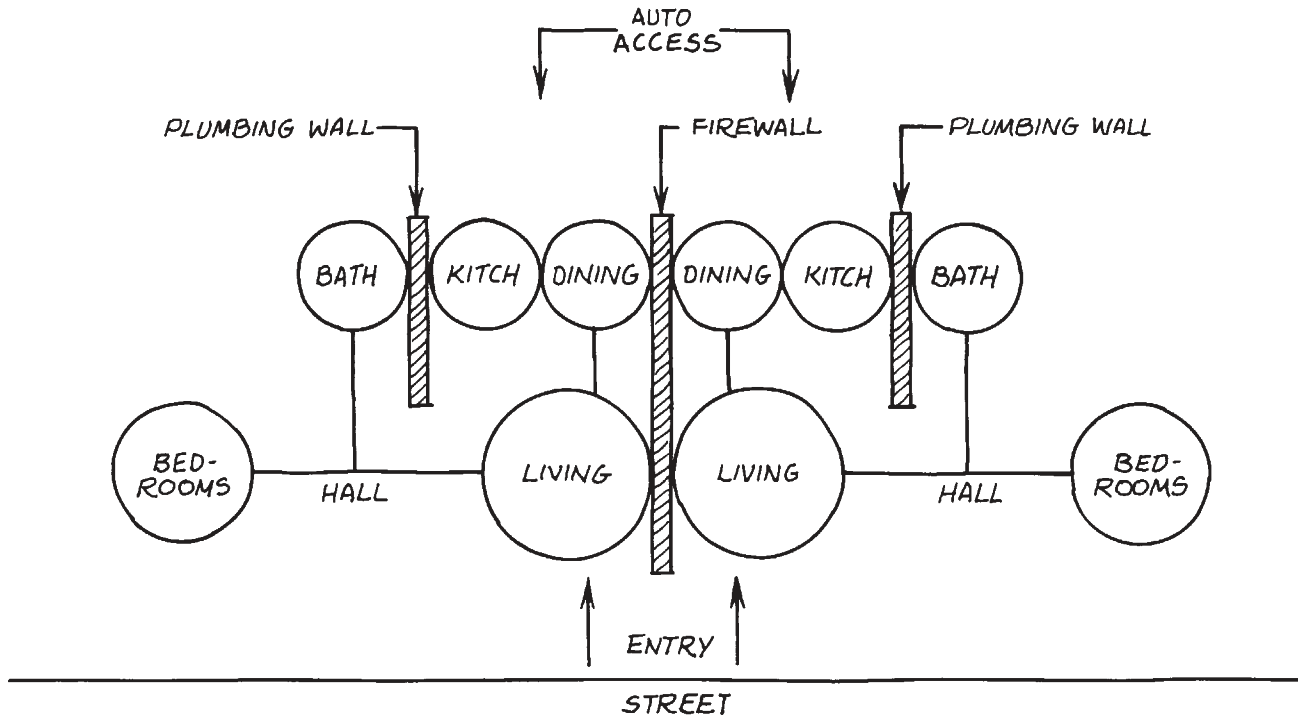

Figure 1-2. Balloon sketch of Duplex.

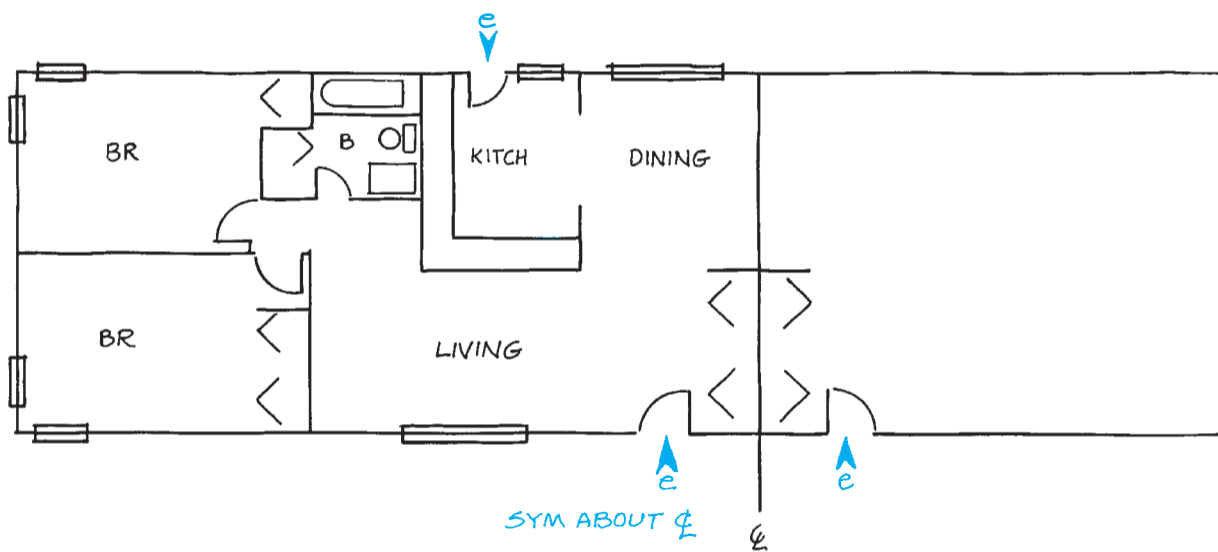

Figure 1-3. Straight line sketch of Duplex.



Before all the details of the design can be finalized, other construction professionals become involved. Building codes specify requirements to ensure that buildings are safe from fire hazards, earthquakes, termites, surface water, and other concerns of the community. Most building codes are based on a model code. For example, the International Code Council (ICC) publishes several model codes, one of which is the *International Building Code*<sup>®</sup>. It is commonly referred to as the IBC. Another is the *International Residential Code*<sup>®</sup> for One- and Two-Family Dwellings, the IRC, which includes all of the parts of the IBC that pertain to one- and two-family dwellings plus some additional content that applies to these dwellings (see **Figure 1–4**). The IRC is a model code, because it is a model that may be used by state and local building authorities as a basis for their own local code. A model code has no authority on its own. The government having jurisdiction in a locale must adopt its own building code. Very often the government body having jurisdiction (called the *Authority Having Jurisdiction*, or AHJ) adopts the model code. Sometimes the AHJ adds specific clauses to the model, and, in rare cases, it writes an all-new code. State building codes allow local governments to adopt a local



## GREEN NOTE

*The design and planning for a green home involves not only the owner and designer, but the general contractor and key trade contractors as well. The designer's preliminary house plans are reviewed by those who will build the home, each looking for ways to improve energy efficiency, incorporate durable construction details, and simplify utility systems installation. Group meetings are often conducted in which the designer, owner, contractor, and key trade contractors discuss the plans and examine the impact of each recommendation and how the work will be carried out. The general contractor and trade contractors can also recommend green building materials that best suit the project.*

building code, but they require that the local code be at least as stringent as the state code.

The local building code is administered by a building department of the local government. The building department reviews the architect's plans before construction begins and inspects the construction throughout its progress to ensure that the code is followed.

Most communities also have zoning laws. A *zoning law* divides the community into zones where only certain types of buildings are permitted. Zoning laws prevent such problems as factories and shopping centers being built in the same neighborhood as homes.

Building departments usually require that very specific procedures are followed for each construction project. A building permit is required before construction begins. The building permit notifies the building department about planned construction. Then, the building department can make sure that the building complies with all the local zoning laws and building codes. When the building department approves the completed construction, it issues a *certificate of occupancy*. This certificate is not issued until the building department is satisfied that the construction has been completed according to the local code. The certificate of occupancy is usually issued after a final inspection by the building inspector. The owner is not permitted to move into the new building until the certificate of occupancy has been issued.

If the building is more complex than a home or simple frame building, engineers may be hired to help

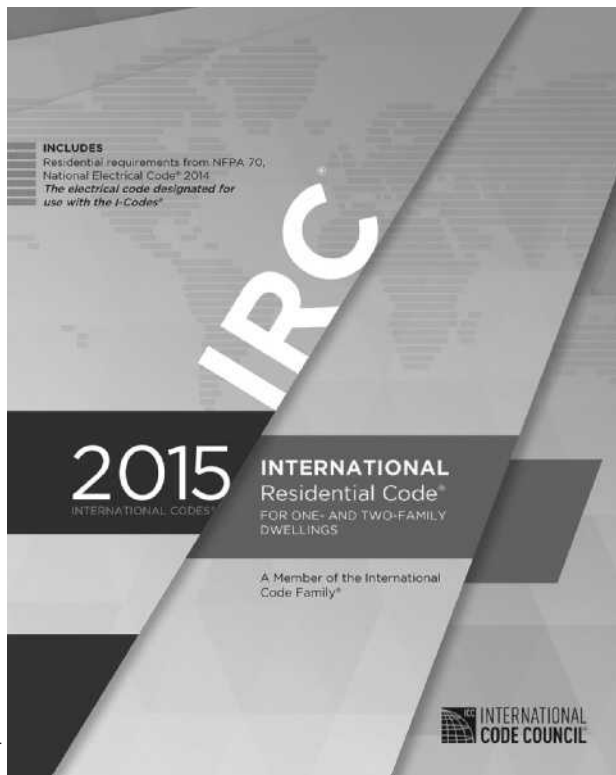

Copyright © 2015 International Code Council, Inc., www.iccsafe.org. All rights reserved. Excerpts reprinted with permission.

**Figure 1–4.** 2015 *International Residential Code*<sup>®</sup> for One- and Two-Family Dwellings.

design the structural, mechanical, electrical, or other aspects of the building. Consulting engineers specialize in certain aspects of construction and are employed by architects to provide specific services. Finally, architects and their consultants prepare construction drawings that show all aspects of the building. These drawings tell the contractor specifically what to build.

Some homes are built from stock plans available from catalogs of house designs, building materials dealers, or magazines (see **Figure 1-5**). However, many states require a registered architect to approve the design and supervise the construction.

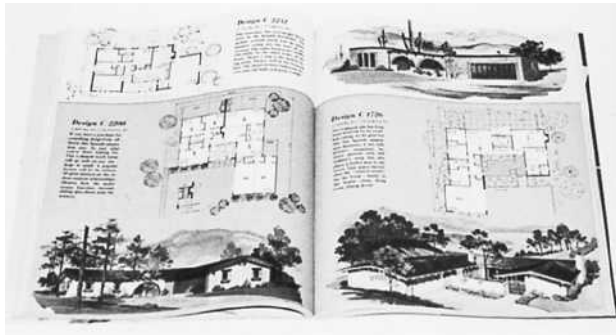
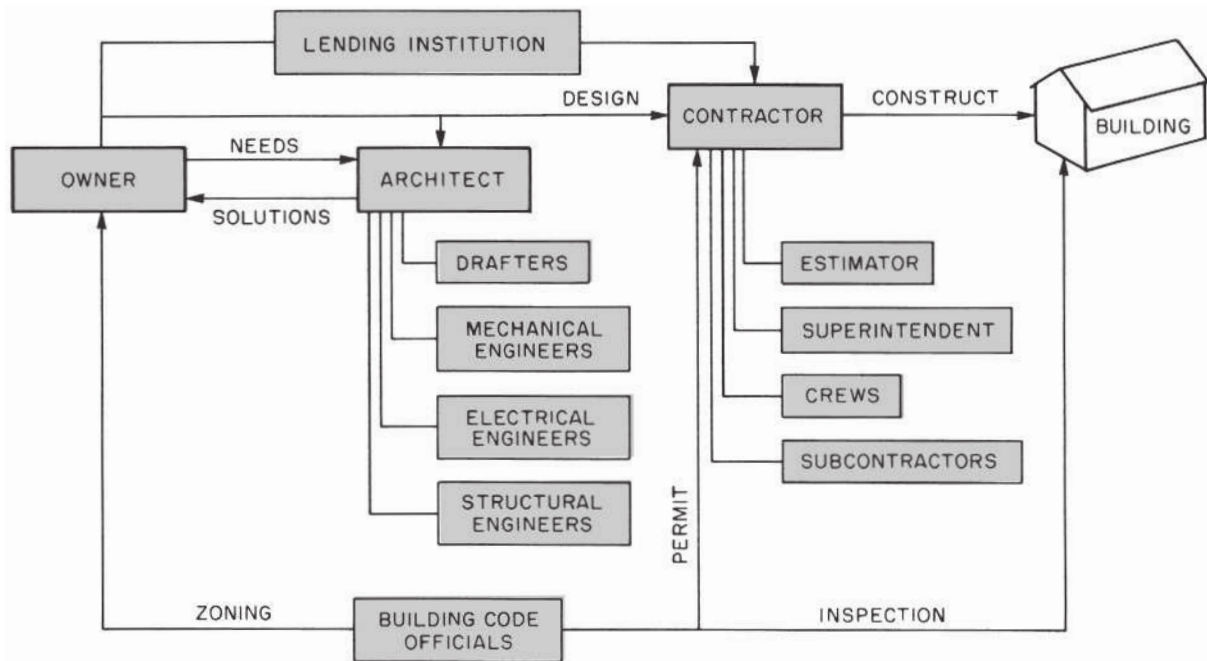

**Figure 1-5.** Stock plans can be ordered from catalogs.

## Starting Construction

After the architect and the owner decide on a final design, the owner obtains financing. The most common way of financing a home is through a mortgage. A *mortgage* is a guarantee that the loan will be paid in installments. If the loan is not paid, the lender has the right to sell the building in order to recover the money owed. In return for the use of the lender's money, the borrower pays interest—a percentage of the outstanding balance of the loan.

When financing has been arranged (sometimes before it is finalized), a contractor is hired. Usually, a general contractor is hired with overall responsibility for completing the project. The general contractor in turn hires subcontractors to complete certain parts of the project. All stages of construction may be subcontracted. The parts of home construction most often subcontracted are excavation, plumbing and heating, electrical, drywall, painting and decorating, and landscaping. The relationships of all the members of the design and construction team are shown in **Figure 1-6**. Utility installers should carefully investigate all the drawings, especially the architectural drawings, in order to determine the installation locations of their equipment.



**Figure 1-6.** Design and construction team.



## USING WHAT YOU LEARNED

Everyone involved in the design, construction, and ownership of a building needs to know who the major players are in the process. Only by understanding what role each agency, company, and individual plays in the process can a construction worker know where to go with questions and for information. For example, no work can begin on the site until a building permit has been issued. The owner, contractor, and superintendent all need to know who issues that permit. Building permits are issued by the building department of the city, town, or county where the building is to be constructed.

## Assignment

1. Who acts as the owner's agent while the building is being constructed?
2. Who designs the structural aspects of a commercial building?
3. Who would normally hire an electrical engineer for the design of a store?
4. Who is generally responsible for obtaining financing for a small building?
5. To whom would the general contractor go if there were a problem with the foundation design for a home?
6. If local building codes require specific features for earthquake protection, who is responsible for seeing that they are included in a home design?
7. Whom would the owner inform about last-minute changes in the interior trim when the building is under construction?
8. What regulations specify what parts of the community are to be reserved for single-family homes only?
9. Who issues the building permit?
10. What regulations are intended to ensure that all new construction is safe?

# UNIT 2

## Views

### Objectives

After completing this unit, you will be able to perform the following tasks:

- Recognize oblique, isometric, and orthographic drawings.
- Draw simple isometric sketches.
- Identify plan views, elevations, and sections.

### Isometric Drawings

A useful type of pictorial drawing for construction purposes is the *isometric drawing*. In an isometric drawing, vertical lines are drawn vertically, and horizontal lines are drawn at an angle of  $30^\circ$  from horizontal, as shown in **Figure 2-1**. All lines on one of these isometric axes are drawn in proportion to their actual length. Isometric drawings tend to look out of proportion because we are used to seeing the object appear smaller as it gets farther away.

Isometric drawings are often used to show plumbing layout (see **Figure 2-2**). The ability to draw simple isometric sketches is a useful skill for communicating on the job site. Try sketching a brick in isometric as shown in **Figure 2-3**.

- Step 1. Sketch a Y with the top lines about  $30^\circ$  from horizontal.
- Step 2. Sketch the bottom edges parallel to the top edges.
- Step 3. Mark off the width on the left top and bottom edges. This will be about twice the height.
- Step 4. Mark off the length on the right top and bottom edges. The length will be about twice the width.
- Step 5. Sketch the two remaining vertical lines and the back edges.

Other isometric shapes can be sketched by adding to or subtracting from this basic isometric brick (see **Figure 2-4**). Angled surfaces are sketched by locating their edges and then connecting them.

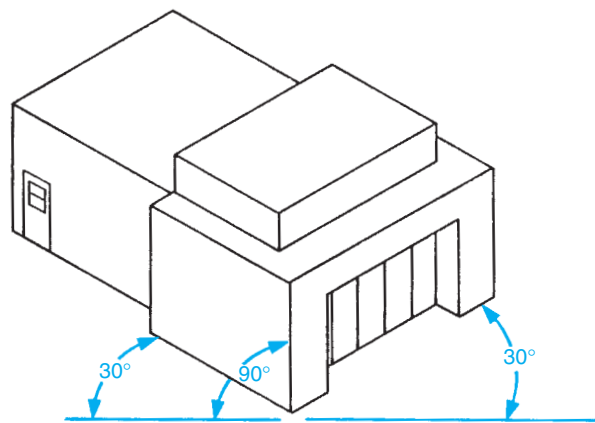

**Figure 2-1.** Isometric of building.



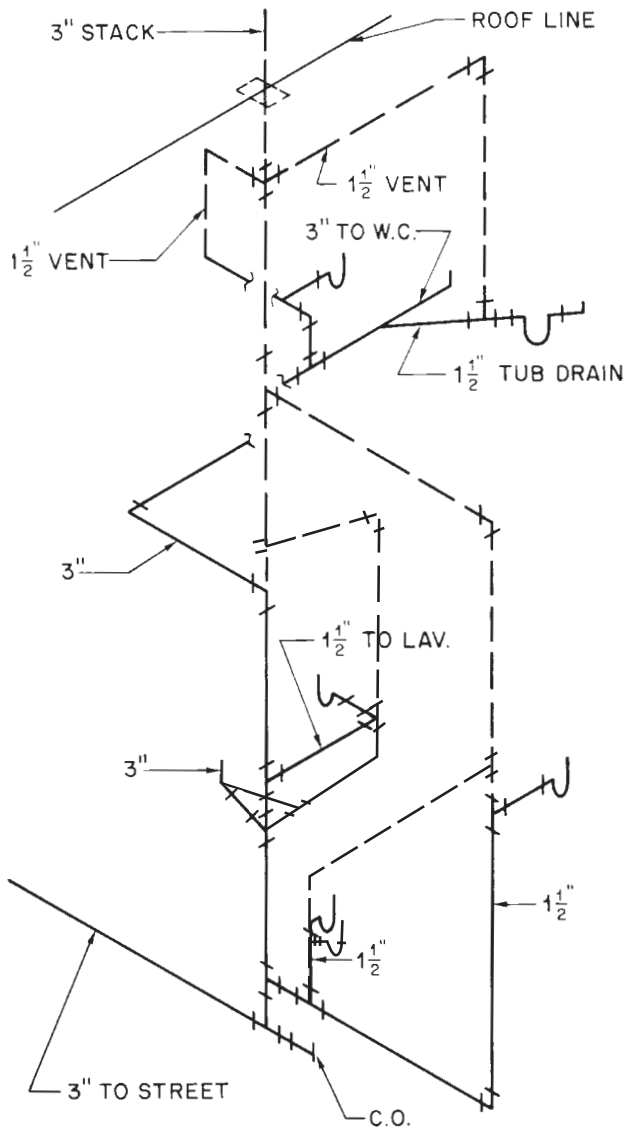

Figure 2-2. Single-line plumbing isometric.

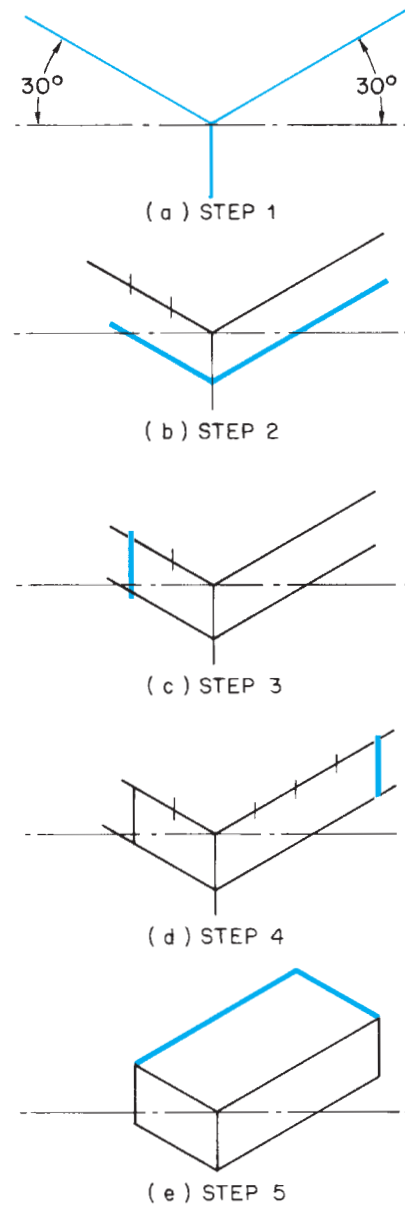

Figure 2-3. Sketching an isometric brick.



### GREEN NOTE

Waste water is classified as either black water or gray water. Black water is that which is discharged from toilets and kitchens, where the water can be very contaminated and must be extensively treated before it can be released into the environment or reused. Gray water is from sinks, laundry areas, and storm water and is less dangerous to the environment. It is becoming increasingly common for green homes to treat gray water and reuse it for irrigation and toilets.

## Oblique Drawings

When an irregular shape is to be shown in a pictorial drawing, an *oblique drawing* may be best. In oblique drawings, the most irregular surface is drawn in proportion as though it were flat against the drawing surface. Parallel lines are added to show the depth of the drawing as shown in **Figure 2-5**.

## Orthographic Projection

To show all information accurately and to keep all lines and angles in proportion, most construction drawings