

This International Student Edition is for use outside of the U.S.

Tenth Edition

Engineering Circuit Analysis

**Mc
Graw
Hill**

William H. Hayt, Jr. | Jack E. Kemmerly
Jamie D. Phillips | Steven M. Durbin

This International Student Edition is for use outside of the U.S.

Tenth Edition

Engineering Circuit Analysis

**Mc
Graw
Hill**

William H. Hayt, Jr. | Jack E. Kemmerly
Jamie D. Phillips | Steven M. Durbin



ENGINEERING CIRCUIT ANALYSIS

TENTH EDITION

William H. Hayt, Jr.
Purdue University

Jack E. Kemmerly
California State University, Fullerton

Jamie D. Phillips
University of Delaware

Steven M. Durbin
Western Michigan University





ENGINEERING CIRCUIT ANALYSIS

Published by McGraw Hill LLC, 1325 Avenue of the Americas, New York, NY 10019. Copyright ©2024 by McGraw Hill LLC. All rights reserved.

Printed in the United States of America. No part of this publication may be reproduced or distributed in any form or by any means, or stored in a database or retrieval system, without the prior written consent of McGraw Hill LLC, including, but not limited to, in any network or other electronic storage or transmission, or broadcast for distance learning.

Some ancillaries, including electronic and print components, may not be available to customers outside the United States.

This book is printed on acid-free paper.

1 2 3 4 5 6 7 8 9 LWI 28 27 26 25 24 23

ISBN 978-1-266-26249-4

MHID 1-266-26249-0

Cover Image: *Timofeev Vladimir/Shutterstock*

All credits appearing on page or at the end of the book are considered to be an

extension of the copyright page.

The Internet addresses listed in the text were accurate at the time of publication. The inclusion of a website does not indicate an endorsement by the authors or McGraw Hill LLC, and McGraw Hill LLC does not guarantee the accuracy of the information presented at these sites.

 [**mheducation.com/highered**](https://mheducation.com/highered)

To Sean and Kristi
The best part of every day.

Page v

Page vi

ABOUT THE AUTHORS

WILLIAM H. HAYT, Jr., received his B.S. and M.S. at Purdue University and his Ph.D. from the University of Illinois. After spending four years in industry, Professor Hayt joined the faculty of Purdue University, where he served as Professor and Head of the School of Electrical Engineering, and as Professor Emeritus after retiring in 1986. Besides *Engineering Circuit Analysis*, Professor Hayt authored three other texts, including *Engineering Electromagnetics*, now in its eighth edition with McGraw Hill. Professor Hayt's professional society memberships included Eta Kappa Nu, Tau Beta Pi, Sigma Xi, Sigma Delta Chi, Fellow of IEEE, ASEE, and NAEB. While at Purdue, he received numerous teaching awards, including the university's Best Teacher Award. He is also listed in Purdue's Book of Great Teachers, a permanent wall display in the Purdue Memorial Union, dedicated on April 23, 1999. The book bears the names of the inaugural group of 225 faculty members, past and present, who have devoted their lives to excellence in teaching and scholarship. They were chosen by their students and their peers as Purdue's finest educators.

JACK E. KEMMERLY received his B.S. magna cum laude from The Catholic University of America, M.S. from University of Denver, and Ph.D. from Purdue University. Professor Kemmerly first taught at Purdue University and later worked as principal engineer at the Aeronutronic Division of Ford Motor Company. He then joined California State University, Fullerton, where he served as Professor, Chairman of the Faculty of Electrical Engineering, Chairman of the Engineering Division, and Professor Emeritus. Professor Kemmerly's professional society memberships included Eta Kappa Nu, Tau Beta Pi, Sigma Xi, ASEE, and IEEE (Senior Member). His pursuits outside of academe included being an officer in the Little League and a scoutmaster in the Boy Scouts.

JAMIE PHILLIPS received his B.S., M.S., and Ph.D. degrees in Electrical Engineering from the University of Michigan, Ann Arbor, Michigan. He was a postdoctoral researcher at Sandia National Laboratories in Albuquerque, New

Mexico, and a research scientist at the Rockwell Science Center in Thousand Oaks, California, before returning to the University of Michigan as a faculty member in the EECS Department in 2002. At the University of Michigan, Prof. Phillips taught and developed numerous courses in circuits and semiconductor devices spanning from first-year undergraduate courses to advanced graduate courses. There he received several teaching honors including the University Undergraduate Teaching Award and an Arthur F. Thurnau Professorship recognizing faculty for outstanding contributions to undergraduate education. In 2020, he joined the University of Delaware as a Professor and Chair of the Electrical and Computer Engineering Department. His research interests are on semiconductor optoelectronic devices with particular emphasis on infrared detectors and photovoltaics and engineering education. His professional memberships include IEEE (Senior Member), Eta Kappa Nu, Optica, Materials Research Society, Tau Beta Pi, and ASEE.

STEVEN M. DURBIN received the B.S., M.S. and Ph.D. degrees in Electrical Engineering from Purdue University, West Lafayette, Indiana. Subsequently, he was with the Department of Electrical Engineering at Florida State University and Florida A&M University before joining the University of Canterbury, New Zealand, in 2000. In 2010, he moved to the University at Buffalo, The State University of New York, where he held a joint tenured appointment between the Departments of Electrical Engineering and Physics. Since 2013, he has been with the Department of Electrical and Computer Engineering at Western Michigan University, where he is Professor of Electrical and Computer Engineering, and has served in a variety of administrative roles. His teaching interests include circuits, electronics, electromagnetics, solid-state electronics and nanotechnology. His research interests are primarily concerned with the development of novel electronic materials—in particular those based on oxide and nitride compounds—as well as studying disorder in both naturally occurring and synthetic systems as a route to physical understanding and engineering of properties. He is a founding principal investigator of the MacDiarmid Institute for Advanced Materials and Nanotechnology, a New Zealand National Centre of Research Excellence, and coauthor of over 100 technical publications, including several patents and patents pending. He is a senior member of the IEEE, and a

member of Eta Kappa Nu, Tau Beta Pi, the Materials Research Society, the AVS (formerly the American Vacuum Society), the Society of Amateur Radio Astronomers, the American Physical Society, and the Royal Society of New Zealand. In his spare time, he enjoys building acoustic and electric guitars, and solid-top ukuleles.

BRIEF CONTENTS

PREFACE [xv](#)

- 1 ● INTRODUCTION [1](#)
 - 2 ● BASIC COMPONENTS AND ELECTRIC CIRCUITS [9](#)
 - 3 ● VOLTAGE AND CURRENT LAWS [43](#)
 - 4 ● BASIC NODAL AND MESH ANALYSIS [85](#)
 - 5 ● HANDY CIRCUIT ANALYSIS TECHNIQUES [133](#)
 - 6 ● THE OPERATIONAL AMPLIFIER [185](#)
 - 7 ● CAPACITORS AND INDUCTORS [223](#)
 - 8 ● BASIC RC AND RL CIRCUITS [267](#)
 - 9 ● THE RLC CIRCUIT [319](#)
 - 10 ● SINUSOIDAL STEADY-STATE ANALYSIS [375](#)
 - 11 ● AC CIRCUIT POWER ANALYSIS [425](#)
 - 12 ● POLYPHASE CIRCUITS [465](#)
 - 13 ● MAGNETICALLY COUPLED CIRCUITS [503](#)
 - 14 ● CIRCUIT ANALYSIS IN THE s -DOMAIN [541](#)
 - 15 ● FREQUENCY RESPONSE [611](#)
 - 16 ● TWO-PORT NETWORKS [683](#)
 - 17 ● FOURIER CIRCUIT ANALYSIS [729](#)
 - 18 ● STATE-VARIABLE ANALYSIS (ONLINE)
-
- Appendix 1 AN INTRODUCTION TO NETWORK TOPOLOGY [787](#)
- Appendix 2 SOLUTION OF SIMULTANEOUS EQUATIONS [799](#)
- Appendix 3 A PROOF OF THÉVENIN'S THEOREM [807](#)
- Appendix 4 AN LTspice® TUTORIAL [809](#)
- Appendix 5 COMPLEX NUMBERS [813](#)
- Appendix 6 A BRIEF MATLAB® TUTORIAL [823](#)
- Appendix 7 ADDITIONAL LAPLACE TRANSFORM THEOREMS [829](#)
- Appendix 8 THE COMPLEX FREQUENCY PLANE [835](#)
- INDEX [843](#)

ADDITIONAL CONTENT  860



501-1111

CONTENTS

PREFACE  xv

CHAPTER 1

INTRODUCTION  1

1.1 Overview of Text  2

1.2 Relationship of Circuit Analysis to Engineering  4

1.3 Analysis and Design  5

1.4 Computer-Aided Analysis  6

1.5 Successful Problem-Solving Strategies  7

 READING FURTHER  8

 EXERCISES  8

CHAPTER 2

BASIC COMPONENTS AND ELECTRIC CIRCUITS  9

2.1 Units and Scales  9

2.2 Charge, Current, Voltage, Power, and Energy  11

2.3 Voltage and Current Sources  19

2.4 Ohm's Law  24

 SUMMARY AND REVIEW  31











 READING FURTHER  32

 EXERCISES  33











CHAPTER 3

VOLTAGE AND CURRENT LAWS  43





3.1 Nodes, Paths, Loops, and Branches  43





- 3.2 Kirchhoff's Current Law  44
- 3.3 Kirchhoff's Voltage Law  46
- 3.4 The Single-Loop Circuit  50
- 3.5 The Single-Node-Pair Circuit  53
- 3.6 Series and Parallel Connected Sources  56
- 3.7 Resistors in Series and Parallel  59
- 3.8 Voltage and Current Division  66
- SUMMARY AND REVIEW  70
- READING FURTHER  71
- EXERCISES  71

CHAPTER 4









- BASIC NODAL AND MESH ANALYSIS  85
- 4.1 Nodal Analysis  86
- 4.2 The Supernode  95
- 4.3 Mesh Analysis  99
- 4.4 The Supermesh  106
- 4.5 Nodal vs. Mesh Analysis: A Comparison  109
- 4.6 Computer-Aided Circuit Analysis  111
- SUMMARY AND REVIEW  114
- READING FURTHER  117
- EXERCISES  117

CHAPTER 5











- HANDY CIRCUIT ANALYSIS TECHNIQUES  133
- 5.1 Linearity and Superposition  133
- 5.2 Source Transformations  144
- 5.3 Thévenin and Norton Equivalent Circuits  152
- 5.4 Maximum Power Transfer  163

- 5.5 Delta-Wye Conversion  166
- 5.6 Selecting an Approach: A Summary of Various Techniques  168
- SUMMARY AND REVIEW  169
- READING FURTHER  170
- EXERCISES  171













CHAPTER 6

- THE OPERATIONAL AMPLIFIER  185
- 6.1 Background  185
- 6.2 The Ideal Op Amp  186
- 6.3 Cascaded Stages  194
- 6.4 Practical Considerations  197
- 6.5 Comparators and the Instrumentation Amplifier  205
- SUMMARY AND REVIEW  211
- READING FURTHER  212
- EXERCISES  213











CHAPTER 7

- CAPACITORS AND INDUCTORS  223
- 7.1 The Capacitor  223
- 7.2 The Inductor  231
- 7.3 Inductance and Capacitance Combinations  241
- 7.4 Linearity and Its Consequences  244
- 7.5 Simple Op Amp Circuits with Capacitors  246
- 7.6 Duality  248
- 7.7 Computer Modeling of Circuits with Capacitors and Inductors  251
- SUMMARY AND REVIEW  254
- READING FURTHER  255
- EXERCISES  255













CHAPTER 8

- BASIC RC AND RL CIRCUITS  267
- 8.1 The Source-Free *RC* Circuit  267
- 8.2 Properties of the Exponential Response  271
- 8.3 The Source-Free *RL* Circuit  275
- 8.4 A More General Perspective  279
- 8.5 The Unit-Step Function  284
- 8.6 Driven *RC* Circuits  288
- 8.7 Driven *RL* Circuits  294
- 8.8 Predicting the Response of Sequentially Switched Circuits  297
- SUMMARY AND REVIEW  305
- READING FURTHER  306
- EXERCISES  307











CHAPTER 9

- THE RLC CIRCUIT  319
- 9.1 The Source-Free Parallel Circuit  319
- 9.2 The Overdamped Parallel *RLC* Circuit  325
- 9.3 Critical Damping  333
- 9.4 The Underdamped Parallel *RLC* Circuit  337
- 9.5 The Source-Free Series *RLC* Circuit  345
- 9.6 The Complete Response of the *RLC* Circuit  351
- 9.7 The Lossless *LC* Circuit  359
- SUMMARY AND REVIEW  363
- READING FURTHER  364
- EXERCISES  364









CHAPTER 10

- SINUSOIDAL STEADY-STATE ANALYSIS  375
- 10.1 Characteristics of Sinusoids  375
- 10.2 Forced Response to Sinusoidal Functions  378
- 10.3 The Complex Forcing Function  382
- 10.4 The Phasor  387
- 10.5 Impedance and Admittance  393
- 10.6 Nodal and Mesh Analysis  398
- 10.7 Superposition, Source Transformations, and Thévenin's Theorem  401
- 10.8 Phasor Diagrams  410
- SUMMARY AND REVIEW  413
- READING FURTHER  414
- EXERCISES  414









CHAPTER 11

- AC CIRCUIT POWER ANALYSIS  425
- 11.1 Instantaneous Power  426
- 11.2 Average Power  428
- 11.3 Maximum Power Transfer  435
- 11.4 Effective Values of Current and Voltage  440
- 11.5 Apparent Power and Power Factor  445
- 11.6 Complex Power  448
- SUMMARY AND REVIEW  454
- READING FURTHER  455
- EXERCISES  456









CHAPTER 12

- POLYPHASE CIRCUITS  465
- 12.1 Polyphase Systems  466
- 12.2 Single-Phase Three-Wire Systems  468
- 12.3 Three-Phase Y-Y Connection  472
- 12.4 The Delta (Δ) Connection  478
- 12.5 Power Measurement in Three-Phase Systems  484
- SUMMARY AND REVIEW  495
- READING FURTHER  497
- EXERCISES  497

CHAPTER 13

- MAGNETICALLY COUPLED CIRCUITS  503
- 13.1 Mutual Inductance  503
- 13.2 Energy Considerations  511
- 13.3 The Linear Transformer  515
- 13.4 The Ideal Transformer  522
- SUMMARY AND REVIEW  531
- READING FURTHER  532
- EXERCISES  532

CHAPTER 14

- CIRCUIT ANALYSIS IN THE s-DOMAIN  541
- 14.1 Complex Frequency  541
- 14.2 Definition of the Laplace Transform  545
- 14.3 Laplace Transforms of Simple Time Functions  548
- 14.4 Inverse Transform Techniques  550
- 14.5 Basic Theorems for the Laplace Transform  557
- 14.6 The Initial-Value and Final-Value Theorems  564
- 14.7 $Z(s)$ and $Y(s)$  567







- 14.8 Nodal and Mesh Analysis in the s-Domain [573](#)
- 14.9 Additional Circuit Analysis Techniques [580](#)
- 14.10 Poles, Zeros, and Transfer Functions [583](#)
- 14.11 Convolution [585](#)
- 14.12 A Technique for Synthesizing the Voltage Ratio $\mathbf{H}(s) = \mathbf{V}_{\text{out}}/\mathbf{V}_{\text{in}}$
[595](#)
 - SUMMARY AND REVIEW [599](#)
 - READING FURTHER [601](#)
 - EXERCISES [602](#)

CHAPTER 15















- FREQUENCY RESPONSE [611](#)
 - 15.1 Transfer Function [611](#)
 - 15.2 Bode Diagrams [614](#)
 - 15.3 Parallel Resonance [629](#)
 - 15.4 Bandwidth and High- Q Circuits [636](#)
 - 15.5 Series Resonance [642](#)
 - 15.6 Other Resonant Forms [645](#)
 - 15.7 Scaling [653](#)
 - 15.8 Basic Filter Design [656](#)
 - 15.9 Advanced Filter Design [666](#)
 - SUMMARY AND REVIEW [671](#)
 - READING FURTHER [672](#)
 - EXERCISES [672](#)

CHAPTER 16

- TWO-PORT NETWORKS [683](#)
 - 16.1 One-Port Networks [683](#)
 - 16.2 Admittance Parameters [688](#)

- 16.3 Some Equivalent Networks  695
- 16.4 Impedance Parameters  704
- 16.5 Hybrid Parameters  709
- 16.6 Transmission Parameters  712
- SUMMARY AND REVIEW  716
- READING FURTHER  717
- EXERCISES  718

CHAPTER 17

- FOURIER CIRCUIT ANALYSIS  729
- 17.1 Trigonometric Form of the Fourier Series  730
- 17.2 The Use of Symmetry  739
- 17.3 Complete Response to Periodic Forcing Functions  744
- 17.4 Complex Form of the Fourier Series  746
- 17.5 Definition of the Fourier Transform  753
- 17.6 Some Properties of the Fourier Transform  757
- 17.7 Fourier Transform Pairs for Some Simple Time Functions  760
- 17.8 The Fourier Transform of a General Periodic Time Function  765
- 17.9 The System Function and Response in the Frequency Domain  766
- 17.10 The Physical Significance of the System Function  774
- SUMMARY AND REVIEW  778
- READING FURTHER  780
- EXERCISES  780

CHAPTER 18 (ONLINE)











STATE-VARIABLE ANALYSIS

- 18.1 State Variables and Normal-Form Equations
- 18.2 Writing a Set of Normal-Form Equations

- 18.3 The Use of Matrix Notation
- 18.4 Solution of the First-Order Equation
- 18.5 The Solution of the Matrix Equation
- 18.6 A Further Look at the State-Transition Matrix

SUMMARY AND REVIEW

EXERCISES

- APPENDIX 1 AN INTRODUCTION TO NETWORK TOPOLOGY  787
- APPENDIX 2 SOLUTION OF SIMULTANEOUS EQUATIONS  799
- APPENDIX 3 A PROOF OF THÉVENIN'S THEOREM  807
- APPENDIX 4 AN LTspice® TUTORIAL  809
- APPENDIX 5 COMPLEX NUMBERS  813
- APPENDIX 6 A BRIEF MATLAB® TUTORIAL  823
- APPENDIX 7 ADDITIONAL LAPLACE TRANSFORM THEOREMS
 829
- APPENDIX 8 THE COMPLEX FREQUENCY PLANE  835
- INDEX  843
- ADDITIONAL CONTENT  860

PREFACE

The target audience colors everything about a book, being a major factor in decisions big and small, particularly both the pace and the overall writing style. Consequently, it is important to note that the authors have made the conscious decision to write this book to the **student**, and not to the instructor. Our underlying philosophy is that reading the book should be enjoyable, despite the level of technical detail that it must incorporate. When we look back to the very first edition of *Engineering Circuit Analysis*, it's clear that it was developed specifically to be more of a conversation than a dry, dull discourse on a prescribed set of fundamental topics. To keep it conversational, we've had to work hard at updating the book so that it continues to speak to the increasingly diverse group of students using it all over the world.

Although in many engineering programs the introductory circuits course is preceded or accompanied by an introductory physics course in which electricity and magnetism are introduced (typically from a fields perspective), this is not required to use this book. After finishing the course, many students find themselves truly amazed that such a broad set of analytical tools have been derived from **only three simple scientific laws**—Ohm's law and Kirchhoff's voltage and current laws. The first six chapters assume only a familiarity with algebra and simultaneous equations; subsequent chapters assume a first course in calculus (derivatives and integrals) is being taken in tandem. Beyond that, we have tried to incorporate sufficient details to allow the book to be read on its own.

So, what key features have been designed into this book with the student in mind?

First, individual chapters are organized into relatively short subsections, each having a single primary topic. The language has been updated to remain informal and to flow smoothly. Color is used to highlight important information as opposed to merely improve the aesthetics of the page layout, and white space is provided for jotting down short notes and questions. New terms are defined as they are introduced, and examples are placed strategically

to demonstrate not only basic concepts, but problem-solving approaches as well. Practice problems relevant to the examples are placed in proximity so that students can try out the techniques for themselves before attempting the end-of-chapter exercises. The exercises represent a broad range of difficulties, generally ordered from simpler to more complex, and grouped according to the relevant section of each chapter.

Engineering is an intensive subject to study, and students often find themselves faced with deadlines and serious workloads. This does not mean that textbooks have to be dry and pompous, however, or that coursework should never contain any element of fun. In fact, successfully solving a problem often *is* fun, and learning how to do that can be fun as well.

Determining how to best accomplish this within the context of a textbook is an ongoing process. The authors have always relied on the often very candid feedback received from our own students at Purdue University; the California State University, Fullerton; Fort Lewis College in Durango; the joint engineering program at Florida A&M University and Florida State University; the University of Canterbury (New Zealand); the University at Buffalo, and Western Michigan University. We also rely on comments, corrections, and suggestions from instructors and students worldwide.

The first edition of *Engineering Circuit Analysis* was written by Bill Hayt and Jack Kemmerly, two engineering professors who very much enjoyed teaching, interacting with their students, and training generations of future engineers. It was well received due to its compact structure, “to the point” informal writing style, and logical organization. There is no timidity when it comes to presenting the theory underlying a specific topic, or pulling punches when developing mathematical expressions. Everything, however, was carefully designed to assist students in their learning, present things in a straightforward fashion, and leave theory for theory’s sake to other books. They clearly put a great deal of thought into writing the book, and their enthusiasm for the subject comes across to the reader.

KEY FEATURES OF THE TENTH

EDITION

Great care has been taken to retain key features from the ninth edition which were clearly working well. These include the general layout and sequence of chapters, the basic style of both the text and line drawings, the use of four-color printing where appropriate, numerous worked examples and related practice problems, and grouping of end-of-chapter exercises according to section. Transformers continue to merit their own chapter, and complex frequency is briefly introduced through a student-friendly extension of the phasor technique, instead of indirectly by merely stating the Laplace transform integral. We also have retained the use of icons, an idea first introduced in the sixth edition:



Provides a heads-up to common mistakes and/or potential pitfalls;



Indicates a point that's worth noting;



Denotes a design problem to which there is no unique answer;



Indicates a problem which requires computer-aided analysis.

Indicates an Example that reinforces the flow chart illustrating a typical problem-solving methodology that is presented in Chapter 1.



Circuit analysis is a robust method for training engineering students to think analytically, step-by-step, and returning to check their answers. A flow chart illustrating a typical problem-solving methodology is presented in Chapter 1; these steps are explicitly included in one example in each of the subsequent chapters to reinforce the concept.

The introduction of engineering-oriented analysis and design software in the book has been done with the mind-set that it should assist, not replace, the learning process. Consequently, the computer icon denotes problems that are typically phrased such that the software is used to *verify* answers, and not simply provide them. Both MATLAB® and LTspice® are used in this context.

SPECIFIC CHANGES FOR THE TENTH EDITION INCLUDE:

- New and revised end-of-chapter exercises
- New figures and photos
- Updated screen captures and text descriptions of computer-aided analysis software, and continued use of LTspice as freeware software that is available natively on both Windows and Mac OS platforms
- Updated worked examples and practice problems
- Updates to the Practical Application feature, introduced to help students connect material in each chapter to broader concepts in engineering. Topics include distortion in amplifiers, circuits to measure an electrocardiogram, practical aspects of grounding, resistivity, and the memristor, sometimes called “the missing element”
- Streamlining of text, especially in the worked examples, to get to the point faster

Digital Resources

Proctorio

Remote Proctoring & Browser-Locking Capabilities



Remote proctoring and browser-locking capabilities, hosted by Proctorio within Connect, provide control of the assessment environment by enabling security options and verifying the identity of the student.

Seamlessly integrated within Connect, these services allow instructors to control the assessment experience by verifying identification, restricting browser activity, and monitoring student actions.

Instant and detailed reporting gives instructors an at-a-glance view of potential academic integrity concerns, thereby avoiding personal bias and supporting evidence-based claims.



ReadAnywhere®

Read or study when it's convenient for you with McGraw Hill's free ReadAnywhere® app. Available for iOS or Android smartphones or tablets, ReadAnywhere gives users access to McGraw Hill tools including the eBook and SmartBook® 2.0 or Adaptive Learning Assignments in Connect. Take notes, highlight, and complete assignments offline—all of your work will sync when you open the app with Wi-Fi access. Log in with your McGraw Hill Connect username and password to start learning—anytime, anywhere!

OLC-Aligned Courses Implementing High-Quality Instruction and Assessment through Preconfigured Courseware

In consultation with the Online Learning Consortium (OLC) and our certified Faculty Consultants, McGraw Hill has created pre-configured courseware using OLC's quality scorecard to align with best practices in online course delivery. This turnkey courseware contains a combination of formative assessments, summative assessments, homework, and application activities, and can easily be customized to meet an individual instructor's needs and desired course outcomes. For more information, visit <https://www.mheducation.com/highered/olc>.

Tegrity: Lectures 24/7

Tegrity in Connect is a tool that makes class time available 24/7 by automatically capturing every lecture. With a simple one-click start-and-stop process, you capture all computer screens and corresponding audio in a format that is easy to search, frame by frame. Students can replay any part of

any class with easy-to-use, browser-based viewing on a PC, Mac, or mobile device.

Educators know that the more students can see, hear, and experience class resources, the better they learn. In fact, studies prove it. Tegrity's unique search feature helps students efficiently find what they need, when they need it, across an entire semester of class recordings. Help turn your students' study time into learning moments immediately supported by your lecture. With Tegrity, you also increase intent listening and class participation by easing students' concerns about note-taking. Using Tegrity in Connect will make it more likely you will see students' faces, not the tops of their heads.

Writing Assignment

Available within Connect and Connect Master, the Writing Assignment tool delivers a learning experience to help students improve their written communication skills and conceptual understanding. As an instructor, you can assign, monitor, grade, and provide feedback on writing more efficiently and effectively.

Create Your Book, Your Way

McGraw Hill's Content Collections Powered by Create® is a self-service website that enables instructors to create custom course materials—print and eBooks—by drawing upon McGraw Hill's comprehensive, cross-disciplinary content. Choose what you want from our high-quality textbooks, articles, and cases. Combine it with your content quickly and easily, and tap into other rights-secured, third-party content such as readings, cases, and articles. Content can be arranged in a way that makes the most sense for your course, and you can include the course name and information as well. Choose the best format for your course: color print, black-and-white print, or eBook. The eBook can be included in your Connect course and is available on the free ReadAnywhere® app for smartphone or tablet access as well. When you are

finished customizing, you will receive a free digital copy to review in just minutes! Visit McGraw Hill Create®— www.mcgrawhillcreate.com—today and begin building!

Reflecting the Diverse World Around Us

McGraw Hill believes in unlocking the potential of every learner at every stage of life. To accomplish that, we are dedicated to creating products that reflect, and are accessible to, all the diverse, global customers we serve. Within McGraw Hill, we foster a culture of belonging, and we work with partners who share our commitment to equity, inclusion, and diversity in all forms. In McGraw Hill Higher Education, this includes, but is not limited to, the following:

- Refreshing and implementing inclusive content guidelines around topics including generalizations and stereotypes, gender, abilities/disabilities, race/ethnicity, sexual orientation, diversity of names, and age.
- Enhancing best practices in assessment creation to eliminate cultural, cognitive, and affective bias.
- Maintaining and continually updating a robust photo library of diverse images that reflect our student populations.
- Including more diverse voices in the development and review of our content.
- Strengthening art guidelines to improve accessibility by ensuring meaningful text and images are distinguishable and perceivable by users with limited color vision and moderately low vision.

ACKNOWLEDGMENTS

I joined the book as a co-author in 1999, and sadly never had the opportunity to speak to either Bill or Jack about the revision process. I count myself lucky to have taken a circuits course from Bill Hayt while I was a student at Purdue. He was, without a doubt, a truly excellent instructor.

I am very grateful to the many people at McGraw Hill who assisted with this project and helped make it a reality, especially Heather Ervolino, Product Developer extraordinaire, and an amazing person to work with. I am also grateful to Jamie Phillips, now at the University of Delaware, who joined the author team for the ninth edition and who made many valuable contributions. I would also like to thank the following people for providing technical suggestions and/or photographs: Prof. Damon Miller of Western Michigan University, Prof. Masakazu Kobayashi of Waseda University, Dr. Wade Enright, Prof. Pat Bodger, Prof. Rick Millane, and Mr. Gary Turner of the University of Canterbury, Prof. Richard Blaikie of the University of Otago, and Profs. Reginald Perry and Jim Zheng of Florida A&M University and the Florida State University.

Additionally, I would like to thank the reviewers of the tenth edition text for their suggestions and valued feedback:

Page xx

Andrew Affrunti

The University of Colorado

Mary C Baker

Texas Tech University

Mark M Budnik

Valparaiso University

MVS Chandrashekhar

University of South Carolina

Somnath Chattopadhyay

California State University Northridge

Yinchao Chen

University of South Carolina

Dorina Cornea-Hasegan

Portland Community College

Hoo Kim

LeTourneau University

Michael Maassel

North Dakota State University

Joseph Martel-Foley

Wentworth Institute of Technology

Katharine Polasek

Hope College

Emily Porter

University of Texas at Austin

Mohandas Raj

Cascadia College

Joseph Vincent Rispoli

Purdue University

Mostafa Shiva

California State University, Fullerton

Marcelo Godoy Simoes

Colorado School of Mines

Raman Menon Unnikrishnan

California State University Fullerton

Farah Vandrevala

University at Buffalo

Paul Villeneuve

University of Maine

Kun Yao

University of Georgia

Page xxi

Finally, I would like to briefly thank several other people who have contributed both directly and indirectly to the tenth edition: First and foremost, my wife, Kristi, and our son, Sean, for their patience, understanding, support, welcome distractions, and helpful advice. Throughout the day, it has always been a pleasure to talk to friends and colleagues about what should be taught, how it should be taught, and how to measure learning. In particular, Martin Allen, Richard Blaikie, Steve Carr, Peter Cottrell, Wade Enright, Jeff Gray, Mike Hayes, Bill Kennedy, Susan Lord, Bob Makin, Philippa Martin, Chris McConville, Damon Miller, Reginald Perry, Joan Redwing, Roger Reeves, Dick Schwartz, Leonard Tung, Jim Zheng, and many others have provided me with many useful insights, as did my father, Jesse Durbin, an electrical engineering graduate of the Indiana Institute of Technology.

Steven M. Durbin, Kalamazoo, Michigan



Instructors

The Power of Connections

A complete course platform

Connect enables you to build deeper connections with your students through cohesive digital content and tools, creating engaging learning experiences. We are committed to providing you with the right resources and tools to support all your students along their personal learning journeys.

65%
Less Time
Grading



Laptop: Getty Images; Woman and dog: George Doyle/Getty Images

Every learner is unique

In Connect, instructors can assign an adaptive reading experience with SmartBook® 2.0. Rooted in advanced learning science principles, SmartBook 2.0 delivers each student a personalized experience, focusing students on their learning gaps, ensuring that the time they spend studying is time well-spent. mheducation.com/highered/connect/smartbook

Affordable solutions, added value

Make technology work for you with LMS integration for single sign-on access, mobile access to the digital textbook, and reports to quickly show you how each of your students is doing. And with our Inclusive Access program, you can provide all these tools at the lowest available market price to your students. Ask your McGraw Hill representative for more information.

Solutions for your challenges

A product isn't a solution. Real solutions are affordable, reliable, and come with training and ongoing support when you need it and how you want it. Visit supportateverystep.com for videos and resources both you and your students can use throughout the term.



Students

Get Learning that Fits You

Effective tools for efficient studying

Connect is designed to help you be more productive with simple, flexible, intuitive tools that maximize your study time and meet your individual learning needs. Get learning that works for you with Connect.

Study anytime, anywhere

Download the free ReadAnywhere® app and access your online eBook, SmartBook® 2.0, or Adaptive Learning Assignments when it's convenient, even if you're offline. And since the app automatically syncs with your Connect account, all of your work is available every time you open it. Find out more at mheducation.com/readanywhere



"I really liked this app—it made it easy to study when you don't have your textbook in front of you."

- Jordan Cunningham,
Eastern Washington University

iPhone: Getty Images



Everything you need in one place

Your Connect course has everything you need—whether reading your digital eBook or completing assignments for class—Connect makes it easy to get your work done.

Learning for everyone

McGraw Hill works directly with Accessibility Services Departments and faculty to meet the learning needs of all students. Please contact your Accessibility Services Office and ask them to email accessibility@mheducation.com, or visit mheducation.com/about/accessibility for more information.





CHAPTER 1

Introduction



KEY CONCEPTS

- Linear versus Nonlinear Circuits
- Four Main Categories of Circuit Analysis:
 - DC
 - Transient
 - Sinusoidal
 - Frequency Domain
- Circuit Analysis Beyond Circuits
- Analysis and Design
- Use of Engineering Software
- A Problem-Solving Strategy

Preamble

All engineers have a great deal in common, regardless of their specialty. This is particularly evident when it comes to problem-solving methodology. In fact, many practicing engineers find it is possible to work in a large variety of settings and even outside their traditional field, as their skill set is often transferable to other environments. Today's engineering graduates find themselves employed in a broad range of jobs, from design of individual components and systems, to solving socioeconomic problems such as air and water pollution, urban planning, communication, medical treatments, mass transportation, power generation and distribution, and efficient use and conservation of natural resources.

Circuit analysis has long been a traditional introduction to the **art of problem solving** from an engineering perspective, even for those whose interests lie outside electrical engineering. There are many reasons for this, but one of the best is that in today's world it's extremely unlikely for any engineer to encounter a system that does not in some way include electrical circuitry. As circuits shrink and require less power, and power sources become smaller and cheaper, embedded circuits are seemingly everywhere. Since most engineering situations require a team effort at some stage, a working knowledge of circuit analysis therefore helps to provide everyone on a project with the background needed for effective communication.

Consequently, this book is not just about "circuit analysis" from an engineering perspective it is also about developing basic problem-solving skills as they apply to situations an engineer is likely to encounter. Along the way, we also find that we're developing an intuitive understanding at a general level, and often we can understand a complex system by its analogy to an electrical circuit. Before launching into all this, however, we should begin with a quick preview of the topics found in the remainder of the book, pausing briefly to ponder the difference between analysis and design, and the evolving role computer tools play in modern engineering.



Not all electrical engineers routinely make use of circuit analysis, but they often bring to bear analytical and problem-solving skills learned early on in their careers. A circuit analysis course is one of the first exposures to such concepts.

Solar Mirrors: Darren Baker/Shutterstock; Skyline: Eugene Lu/Shutterstock; Electrocardiogram machine: David Prado Perucha/Shutterstock; Dish: Jonathan Larsen/iStock/Getty Images



1.1 OVERVIEW OF TEXT

The fundamental subject of this text is *linear circuit analysis*, which sometimes prompts a few readers to ask,

“Is there such a thing *nonlinear* circuit analysis?”

Sure! We encounter nonlinear circuits every day: they capture and decode signals for our TVs and radios, perform calculations hundreds of millions (even billions) of times a second inside microprocessors, convert speech into electrical signals for transmission over fiber-optic cables as well as cellular networks, and execute many other functions outside our field of view. In designing, testing, and implementing such nonlinear circuits, detailed analysis is unavoidable.



Flat panel displays include nonlinear circuits. Many of them, however, can be understood, designed, and analyzed with the assistance of linear models.

sdecoret/Shutterstock

“Then why study *linear* circuit analysis?”

you might ask. An excellent question. The simple fact of the matter is that no physical system (including electrical circuits) is ever perfectly linear. Fortunately for us, however, a great many systems behave in a reasonably linear fashion over a limited range—allowing us to model them as linear systems if we keep the range limitations in mind.

For example, consider the common function

$$f(x) = e^x$$

A linear approximation to this function is

$$f(x) \approx 1 + x$$

Let’s test this out.  **Table 1.1** shows both the exact value and the approximate value of $f(x)$ for a range of x . Interestingly, the linear approximation is exceptionally accurate up to about $x = 0.1$, when the relative error is still less than 1%. Although many engineers are rather quick on a calculator, it’s hard to argue that any approach is faster than just adding 1.

TABLE 1.1 Comparison of a Linear Model for e^x to Exact Value

| x | $f(x)^*$ | $1 + x$ | Relative Error** |
|--------|----------|---------|------------------|
| 0.0001 | 1.0001 | 1.0001 | 0.0000005% |
| 0.001 | 1.0010 | 1.001 | 0.00005% |
| 0.01 | 1.0101 | 1.01 | 0.005% |
| 0.1 | 1.1052 | 1.1 | 0.5% |
| 1.0 | 2.7183 | 2.0 | 26% |

*Quoted to four significant figures.

**Relative error $\triangleq \left| 100 \times \frac{e^x - (1 + x)}{e^x} \right|$

Linear problems are inherently more easily solved than their nonlinear counterparts. For this reason, we often seek reasonably accurate linear approximations (or *models*) to physical situations. Furthermore, linear models

are easily manipulated and understood—making the design process more straightforward.

The circuits we will encounter in subsequent chapters all represent linear approximations to physical electric circuits. Where appropriate, brief discussions of potential inaccuracies or limitations to these models are provided, but generally speaking we find them to be suitably accurate for most applications. When greater accuracy is required in practice, nonlinear models are employed, but with a considerable increase in solution complexity. A detailed discussion of what constitutes a *linear electric circuit* can be found in  **Chap. 2.**

Linear circuit analysis can be separated into four broad categories: (1) *dc analysis*, where the energy sources do not change with time; (2) *transient analysis*, where things often change quickly; (3) *sinusoidal analysis*, which applies to both ac power and signals; and (4) *frequency response*, which is the most general of the four categories, but typically assumes something is changing with time. We begin our journey with the topic of resistive circuits, such as an automotive rear window defogger. This provides us with a perfect opportunity to learn a number of powerful engineering circuit analysis techniques, such as *nodal analysis*, *mesh analysis*, *superposition*, *source transformation*, *Thévenin's theorem*, *Norton's theorem*, and several methods for simplifying networks of components connected in series or parallel. The single most redeeming feature of resistive circuits is that the time dependence of any quantity of interest does not affect our analysis procedure. In other words, if asked for an electrical quantity of a resistive circuit at several specific instants in time, we do not need to analyze the circuit more than once. As a result, we will spend most of our initial effort considering dc circuits—those circuits whose electrical parameters do not vary with time.



Modern trains are powered by electric motors. Their electrical systems are best analyzed using ac or phasor analysis techniques.

Dr. Masakazu Kobayashi

Although dc circuits are undeniably important in everyday life, things are often much more interesting when something happens suddenly. In circuit analysis parlance, we refer to *transient analysis* as the suite of techniques used to study circuits that are suddenly energized or de-energized. To make such circuits interesting, we need to add elements that respond to the rate of change of electrical quantities, leading to circuit equations that include derivatives and integrals. Fortunately, we can obtain such equations using the simple techniques learned in the first part of our study.

Still, not all time-varying circuits are turned on and off suddenly. Air conditioners, fans, and lighting fixtures are only a few of the many examples we may see daily. In such situations, a calculus-based approach for every analysis can become tedious and time-consuming. Fortunately, there is a better alternative for situations where equipment has been allowed to run long enough for transient effects to die out, and this is commonly referred to as ac or sinusoidal analysis, or sometimes *phasor analysis*.



Frequency-dependent circuits lie at the heart of many electronic devices, and they can be a great deal of fun to design.

prykhodov/123RF

The final leg of our journey deals with a subject known as *frequency response*. Working directly with the differential equations obtained in time-domain analysis helps us develop an intuitive understanding of the operation of circuits containing energy storage elements (e.g., capacitors and inductors). As we shall see, however, circuits with even a relatively small number of components can be somewhat onerous to analyze, and much more straightforward methods have been developed. These methods, which include Laplace and Fourier analysis, allow us to transform differential equations into algebraic equations. Such methods also enable us to design circuits to respond in specific ways to particular frequencies. We make use of frequency-dependent circuits every day when we use a mobile phone, select our favorite radio station, or connect to the Internet.

1.2 RELATIONSHIP OF CIRCUIT ANALYSIS TO ENGINEERING

It is worth noting that there are several layers to the concepts under study in this text. Beyond the nuts and bolts of circuit analysis techniques lies the opportunity to develop a methodical approach to problem solving, the ability to determine the goal or goals of a particular problem, skill at collecting the information needed to effect a solution, and, perhaps equally importantly, opportunities for practice at verifying solution accuracy.

Students familiar with the study of other engineering topics such as fluid flow, automotive suspension systems, bridge design, supply chain management, or robotics will recognize the general form of many of the equations we develop to describe the behavior of various circuits. We simply need to learn how to “translate” the relevant variables (e.g., replacing *voltage* with *force*, *charge* with *distance*, *resistance* with *friction coefficient*, distance, or resistance with friction coefficient) to find that we already know how to work a new type of problem. Very often, if we have previous experience in solving a similar or related problem, our intuition can guide us through the solution of a totally new problem. An additional benefit to being able to recognize the form common to several problems in different fields is that engineers often cross traditional boundaries between disciplines by utilizing that knowledge and knowing how to apply it.



A molecular beam epitaxy crystal growth facility. The equations governing its operation closely resemble those used to describe simple linear circuits.

Steve Durbin/McGraw Hill



What we are about to learn regarding linear circuit analysis forms the basis for many subsequent electrical engineering courses. The study of electronics relies on the analysis of circuits with devices known as diodes and transistors, which are used to construct power supplies, amplifiers, and digital circuits. The skills which we will develop are typically applied in a rapid, methodical fashion by electronics engineers, who sometimes can analyze a complicated circuit without even reaching for a pencil. The time-domain and frequency-domain chapters of this text lead directly into discussions of signal processing, power transmission, control theory, and communications. We find that frequency-domain analysis in particular is an extremely powerful technique, easily applied to any physical system subjected to time-varying excitation, and particularly helpful in the design of filters.



An example of a robotic manipulator. The feedback control system can be modeled using linear circuit elements to determine situations in which the operation may become unstable.

THINK A/Shutterstock

1.3 ANALYSIS AND DESIGN

Engineers take a fundamental understanding of scientific principles, combine this with practical knowledge often expressed in mathematical terms, and (frequently with considerable creativity) arrive at a solution to a given problem. *Analysis* is the process through which we determine the scope of a problem, obtain the information required to understand it, and compute the parameters of interest. *Design* is the process by which we synthesize something new as part of the solution to a problem. Generally speaking, there is an expectation that a problem requiring design will have no unique solution, whereas the analysis phase typically will. Thus, the last step in designing is always analyzing the result to see if it meets specifications.

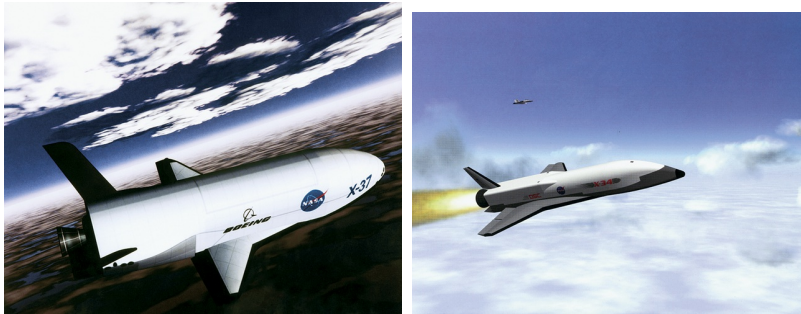

NASA Dryden Flight Research Center NASA Dryden Flight Research Center

Two proposed designs for a next-generation space shuttle.
Although both contain similar elements, each is unique.



This text is focused on developing our ability to analyze and solve problems because it is the starting point in every engineering situation. The philosophy of this book is that we need clear explanations, well-placed examples, and plenty of practice to develop such an ability. Therefore, elements of design are integrated into end-of-chapter problems and later chapters so as to be enjoyable rather than distracting.

1.4 COMPUTER-AIDED ANALYSIS

Solving the types of equations that result from circuit analysis can often become notably cumbersome for even moderately complex circuits. This of course introduces an increased probability that errors will be made, in addition to considerable time in performing the calculations. The desire to find a tool to help with this process actually predates electronic computers, with purely mechanical computers such as the Analytical Engine designed by Charles Babbage in the 1880s proposed as possible solutions. Perhaps the earliest successful electronic computer designed for solution of differential equations was the 1940s-era ENIAC, whose vacuum tubes filled a large room. With the advent of low-cost desktop computers, however, computer-aided circuit analysis has developed into an invaluable everyday tool which has become an integral part of not only analysis but design as well. All of today's computer chips are first designed and analyzed using computer simulations based on a set of known physical rules, which are typically combined with empirical data to account for "real world" performance characteristics. Once the simulations show desired results, the design is then used to provide the information needed to fabricate the real circuit or system. Without computer-aided analysis and design, this process would be nearly impossible, as today's chips contain millions of devices in a single circuit!

One of the most powerful aspects of computer-aided design is the relatively recent integration of multiple programs in a fashion transparent to the user. This allows the circuit to be drawn schematically on the screen, reduced automatically to the format required by an analysis program (such as SPICE, introduced in  **Chap. 4**), and the resulting output smoothly transferred to a third program capable of plotting various electrical quantities of interest that describe the operation of the circuit. Once the engineer is satisfied with the simulated performance of the design, the same software can generate the printed circuit board layout using geometrical parameters in the components library. This level of integration is continually increasing, to the point where it is now possible to draw a schematic, click a few buttons, and walk to the other

side of the table to pick up a manufactured version of the circuit, ready to test!

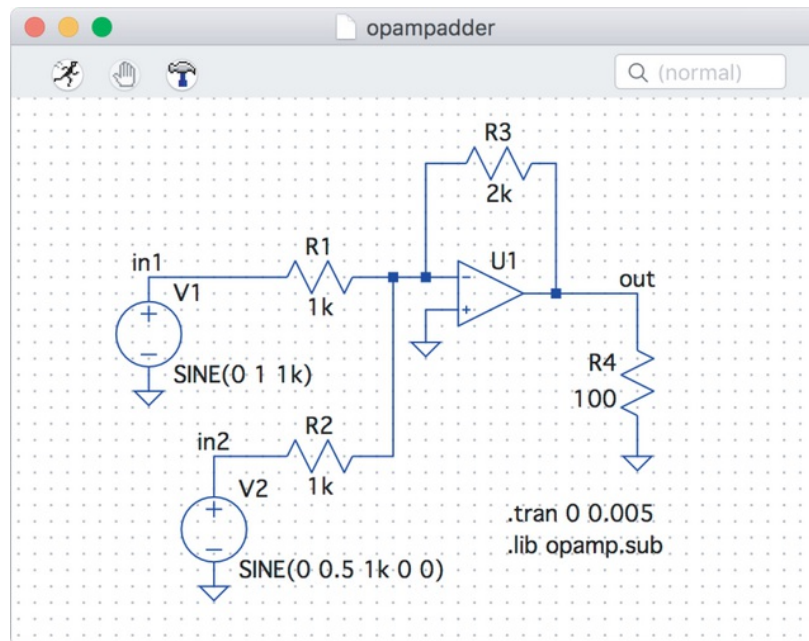

An amplifier circuit drawn using a commercial schematic capture software package.



The reader should be wary, however, of one thing. Circuit analysis software, although fun to use, is by no means a replacement for good old-fashioned paper-and-pencil analysis. We need to have a solid understanding of how circuits work in order to develop an ability to design them. Simply going through the motions of running a particular software package is a little like playing the lottery: with user-generated entry errors, hidden default parameters in the myriad of menu choices, and the occasional shortcoming of human-written code, there is no substitute for having at least an approximate idea of the expected behavior of a circuit. Then, if the simulation result does not agree with expectations, we can find the error early, rather than after it's too late.

Still, computer-aided analysis is a powerful tool. It allows us to vary parameter values and evaluate the change in circuit performance, and to consider several variations to a design in a straightforward manner. The result is a reduction of repetitive tasks, and more time to concentrate on engineering details.

1.5 SUCCESSFUL PROBLEM-SOLVING STRATEGIES

As the reader might have picked up, this book is just as much about problem solving as it is about circuit analysis. During your time as an engineering student, the expectation is that you are learning how to solve problems—just at this moment, those skills are not yet fully developed. As you proceed through your course of study, you will pick up techniques that work for you, and likely continue to do so as a practicing engineer.

By far the most common difficulty encountered by engineering students is *not knowing how to start* a problem. This improves with experience, but early on that's of no help. The best advice we can give is to adopt a methodical approach, beginning with reading the problem statement slowly and carefully (and more than once, if needed). Since experience usually gives us some type of insight into how to deal with a specific problem, worked examples appear throughout the book. Rather than just read them, however, it might be helpful to work through them with a pencil and a piece of paper.

Once we've read through the problem, and feel we might have some Page 8 useful experience, the next step is to identify the goal of the problem—perhaps to calculate a voltage or a power, or to select a component value. Knowing where we're going is a big help. The next step is to collect as much information as we can and to organize it somehow.

At this point *we're still not ready to reach for the calculator*. It's best first to devise a plan, perhaps based on experience, perhaps based simply on our intuition. Sometimes plans work, and sometimes they don't. Starting with our initial plan, it's time to construct an initial set of equations. If they appear complete, we can solve them. If not, we need to either locate more information, modify our plan, or both.

Once we have what appears to be a working solution, we should not stop, even

if exhausted and ready for a break. **No engineering problem is solved unless the solution is tested somehow.** We might do this by performing a computer simulation, or solving the problem a different way, or perhaps even just estimating what answer might be reasonable.

Since not everyone likes to read to learn, these steps are summarized in the flowchart that follows. This is just one problem-solving strategy, and the reader of course should feel free to modify it as necessary. The real key, however, is to try and learn in a relaxed, low-stress environment free of distractions. Experience is the best teacher, and learning from our own mistakes will always be part of the process of becoming a skilled engineer.

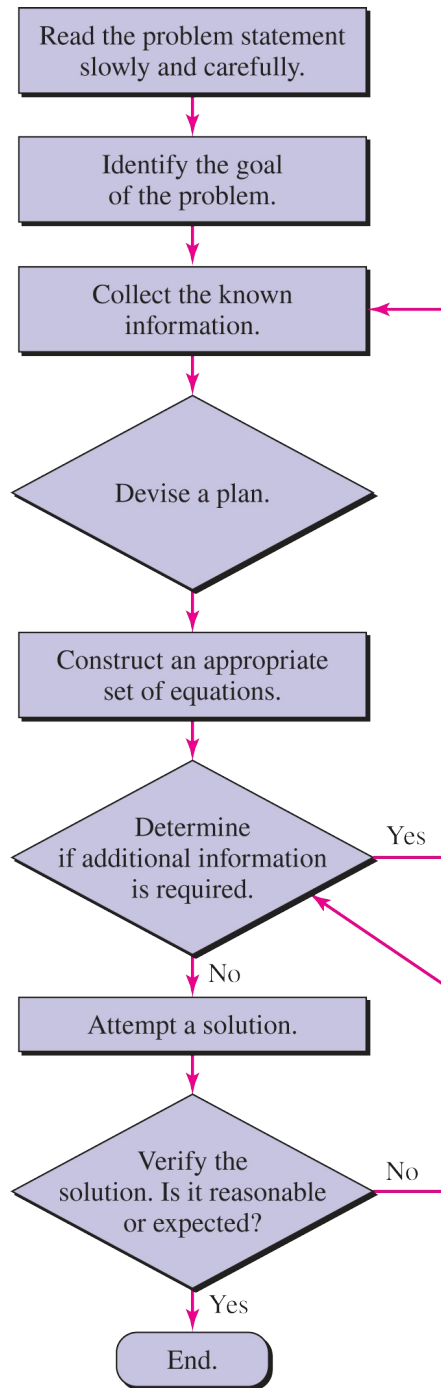

READING FURTHER

This relatively inexpensive classic book teaches the reader how to develop winning strategies in the face of seemingly impossible problems:

G. Polya, *How to Solve It*. Princeton, N.J.: Princeton University Press, 1971.

EXERCISES

1. Consider the function $f(\theta) = 3\theta$ as an approximation to the function $g(\theta) = 3\sin\theta$. Restricting your analysis to the range $0 \leq \theta \leq \pi/2$, determine the value of θ at which the relative error between f and g exceeds 1%. In this context, we define relative error as $100 \times \left| \frac{f(\theta) - g(\theta)}{g(\theta)} \right|$.
2. The function $\frac{1}{1-x}$ can be approximated with the linear function $g(x) = 1 + x$. For what value(s) of x does the linear approximation result in 1% relative error?
3. One common circuit element capable of storing energy is known as the capacitor. When discharging its stored energy, the voltage V_C across the device can be expressed as $V_C = V_0 (1 - e^{-t/\tau})$, where V_0 is the voltage just prior to the start of the discharge process, t is the time, and τ is known as the “time constant.” To avoid errors, t and τ should be measured in the same units (seconds, milliseconds, etc.).
 - (a) Rearrange the expression to solve for t , resulting in an expression containing a natural logarithm.
 - (b) Approximating the natural logarithm as $\ln x \approx x - 1$, determine the relative error of the approximation at $V_C/V_0 =$ (a) 0.10; (b) 0.50.

Design elements: Cockpit: ©Purestock/SuperStock; Wind Turbines: ©Russell Illig/Getty Images; Circuit Board:

©Shutterstock



CHAPTER 2

Basic Components and Electric Circuits



KEY CONCEPTS

- Basic Electrical Quantities and Associated Units: Charge, Current, Voltage, and Power
- Current Direction and Voltage Polarity
- The Passive Sign Convention for Calculating Power
- Ideal Voltage and Current Sources
- Dependent Sources
- Resistance and Ohm's Law

INTRODUCTION

In conducting circuit analysis, we often find ourselves seeking specific *currents*, *voltages*, or *powers*, so here we begin with a brief description of these quantities. In terms of components that can be used to build electrical circuits, we have quite a few from which to choose. We initially focus on the *resistor*, a simple passive component, and a range of idealized active sources of voltage and current. As we move forward, new components will be added to the inventory to allow more complex (and useful) circuits to be considered.

A quick word of advice before we begin: Pay close attention to the role of “+”

and “—” signs when labeling voltages, and the significance of the arrow in defining current: they often make the difference between wrong and right answers.

2.1 UNITS AND SCALES

In order to state the value of some measurable quantity, we must give both a *number* and a *unit*, such as “3 meters.” Fortunately, we all use the same number system. This is not true for units, and a little time must be spent in becoming familiar with a suitable system. We must agree on a standard unit and be assured of its permanence and its general acceptability. The standard unit of length, for example, should not be defined in terms of the distance between two marks on a certain rubber band; this is not permanent, and furthermore everybody else is using another standard.

The most frequently used system of units is the International System of Units (abbreviated *SI* in all languages), adopted by the General Conference on Weights and Measures in 1960. Modified several times since, the SI is built upon seven basic units: the *meter*, *kilogram*, *second*, *ampere*, *kelvin*, *mole*, and *candela* (see [Table 2.1](#)). This is a “metric system,” some form of which is now in common use in most countries of the world, although it is not yet widely used in the United States, despite being adopted by the U.S. National Bureau of Standards in 1964, used by all major professional engineering societies, and the language in which textbook and professional publications are written. Units for other quantities such as volume, force, energy, etc., are derived from the seven base units.

TABLE 2.1 SI Base Units

| Base Quantity | Name | Symbol |
|---------------------------|----------|--------|
| length | meter | m |
| mass | kilogram | kg |
| time | second | s |
| electric current | ampere | A |
| thermodynamic temperature | kelvin | K |
| amount of substance | mole | mol |
| luminous intensity | candela | cd |

There is some inconsistency regarding whether units named after a person should be capitalized. Here, we will adopt the most contemporary convention,^{1,2} where such units are written out in lowercase (e.g., watt, joule), but abbreviated with an uppercase symbol (e.g., W, J).

The fundamental unit of work or energy is the *joule* (J). One joule (a $\text{kg m}^2 \text{s}^{-2}$ in SI base units) is equivalent to 0.7376 foot pound-force (ft · lbf). Other energy units include the calorie (cal), equal to 4.187 J; the British thermal unit (Btu), which is 1055 J; and the kilowatthour (kWh), equal to $3.6 \times 10^6 \text{ J}$. Power is defined as the *rate* at which work is done or energy is expended. The fundamental unit of power is the *watt* (W), defined as 1 J/s. One watt is equivalent to $0.7376 \text{ ft} \cdot \text{lbf/s}$ or, equivalently, 1/745.7 horsepower (hp).

The “calorie” used with food, drink, and exercise is really a kilocalorie, 4.187 J.

The SI uses the decimal system to relate larger and smaller units to the basic unit, and it employs prefixes to signify the various powers of 10. A list of prefixes and their symbols is given in [Table 2.2](#); the ones most commonly encountered in engineering are highlighted.

TABLE 2.2 SI Prefixes

| Factor | Name | Symbol | Factor | Name | Symbol |
|------------|-------|--------|-----------|-------|--------|
| 10^{-24} | yocto | y | 10^{24} | yotta | Y |
| 10^{-21} | zepto | z | 10^{21} | zetta | Z |
| 10^{-18} | atto | a | 10^{18} | exa | E |
| 10^{-15} | femto | f | 10^{15} | peta | P |
| 10^{-12} | pico | p | 10^{12} | tera | T |
| 10^{-9} | nano | n | 10^9 | giga | G |
| 10^{-6} | micro | μ | 10^6 | mega | M |
| 10^{-3} | milli | m | 10^3 | kilo | k |
| 10^{-2} | centi | c | 10^2 | hecto | h |
| 10^{-1} | | | 10^1 | | |

These prefixes are worth memorizing, for they will appear often both in this text and in other technical work. Combinations of several prefixes, such as the millimicrosecond, are unacceptable. It is worth noting that in terms of distance, it is common to see “micron (μm)” as opposed to “micrometer,” and sometimes the angstrom (\AA) is used for 10^{-10} meter. Also, in circuit analysis and engineering in general, it is fairly common to see numbers expressed in what are often termed “engineering units.” In engineering notation, a quantity is represented by a number between 1 and 999 and an appropriate metric unit using a power divisible by 3. So, for example, it is preferable to express the quantity 0.048 W as 48 mW, instead of 4.8 cW, 4.8×10^{-2} W, or 48,000 μW .

PRACTICE

2.1 A krypton fluoride laser emits light at a wavelength of 248 nm. This is the same as:

- (a) 0.0248 mm;
- (b) 2.48 μm ;
- (c) 0.248 μm ;
- (d) 24,800 \AA .

► Ans

2.2 A single logic gate in a prototype integrated circuit is found to be capable of switching from the “on” state to the “off” state in 12 ps. This corresponds to:

- (a) 1.2 ns;
- (b) 120 ns;
- (c) 1200 ns;
- (d) 12,000 ns.

► Ans

2.3 A typical solid-state light bulb runs at 8.5 W. If it is left on constantly, how much energy (J) is consumed per day, and what is the weekly cost if energy is charged at a rate of 12 cents per kilowatthour?

► Ans

2.2 CHARGE, CURRENT, VOLTAGE, POWER, AND ENERGY

Charge

One of the most fundamental concepts in electric circuit analysis is that of charge conservation. We know from basic physics that there are two types of charge: positive (corresponding to a proton) and negative (corresponding to an electron). For the most part, this text is concerned with circuits in which only electron flow is relevant. There are many devices (such as batteries, diodes, and transistors) in which positive charge motion is important to understanding internal operation, but external to the device we typically concentrate on the electrons which flow through the connecting wires. Although we continuously transfer charges between different parts of a circuit, we do nothing to change the total amount of charge. In other words, we neither create nor destroy electrons (or protons) when running electric circuits.³ Charge in motion represents a *current*.

As seen in [Table 2.1](#), the base units of the SI are not derived from fundamental physical quantities. Instead, they represent historically agreed-upon measurements, leading to definitions which occasionally seem backward. For example, it would make more sense physically to define the ampere based on electronic charge.

In the SI system, the fundamental unit of charge is the *coulomb* (C). It is defined in terms of the *ampere* by counting the total charge that passes through an arbitrary cross section of a wire during an interval of one second; one coulomb is measured each second for a wire carrying a current of 1 ampere ([Fig. 2.1](#)). In this system of units, a single electron has a charge of

$-1.602 \times 10^{-19} \text{ C}$ and a single proton has a charge of $+1.602 \times 10^{-19} \text{ C}$.

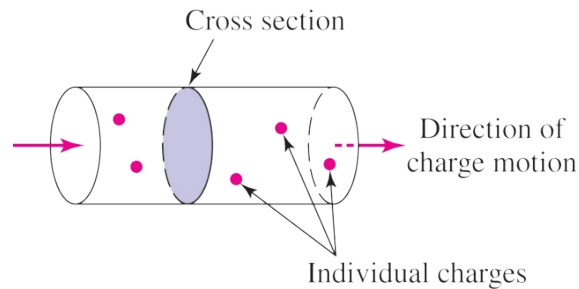

■ FIGURE 2.1 The definition of current illustrated using charge flowing through a wire; 1 ampere corresponds to 1 coulomb of charge passing through the arbitrarily chosen cross section in 1 second.





A quantity of charge that does not change with time is typically represented by Q . The instantaneous amount of charge (which may or may not be time-invariant) is commonly represented by $q(t)$, or simply q . This convention is used throughout the remainder of the text: capital letters are reserved for constant (time-invariant) quantities, whereas lowercase letters represent the more general case. Thus, a constant charge may be represented by *either* Q or q , but an amount of charge that changes over time *must* be represented by the lowercase letter q .

Current

The idea of “transfer of charge” or “charge in motion” is of vital importance to us in studying electric circuits because, in moving a charge from place to place, we may also transfer energy from one point to another. The familiar cross-country power-transmission line is a practical example of a device that transfers energy. Of equal importance is the possibility of varying the rate at which the charge is transferred in order to communicate or transfer information. This process is the basis of modern communication systems, including satellite global positioning systems, 5G (and beyond), and WiFi

Internet connections.

The current flowing in a discrete path, such as a metallic wire, has both a *numerical value* and a *direction* associated with it; it is a measure of the rate at which charge is moving past a given reference point in a specified direction. Once we have specified a reference direction, we may then let $q(t)$ be the total charge that has passed the reference point since an arbitrary time $t = 0$, moving in the defined direction. A contribution to this total charge will be negative if negative charge is moving in the reference direction, or if positive charge is moving in the opposite direction. As an example,  Fig. 2.2 shows a history of the total charge $q(t)$ that has passed a given reference point in a wire (such as the one shown in  Fig. 2.1).

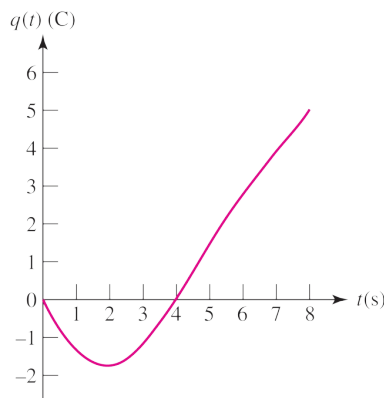

■ FIGURE 2.2 A graph of the instantaneous value of the total charge $q(t)$ that has passed a given reference point since $t = 0$.



We define the current at a specific point and flowing in a specified direction as the instantaneous rate at which net positive charge is moving past that point in the specified direction. This, unfortunately, is the historical definition, which came into popular use before it was appreciated that current in wires is actually due to negative, not positive, charge motion. Current is symbolized by I or i , and so

$$i = \frac{dq}{dt} \quad [1]$$

The unit of current is the ampere (A), named after A. M. Ampère, a French physicist. It is commonly abbreviated as an “amp,” although this is unofficial and somewhat informal. One ampere equals 1 coulomb per second.

Using [Eq. \[1\]](#), we compute the instantaneous current corresponding to [Fig. 2.2](#) and obtain [Fig. 2.3](#). The use of the lowercase letter i is again to be associated with an instantaneous value; an uppercase I would denote a constant (i.e., time-invariant) quantity. The charge transferred between time t_0 and t may be expressed as a definite integral:

$$\int_{q(t_0)}^{q(t)} dq = \int_{t_0}^t i dt' \quad [2]$$

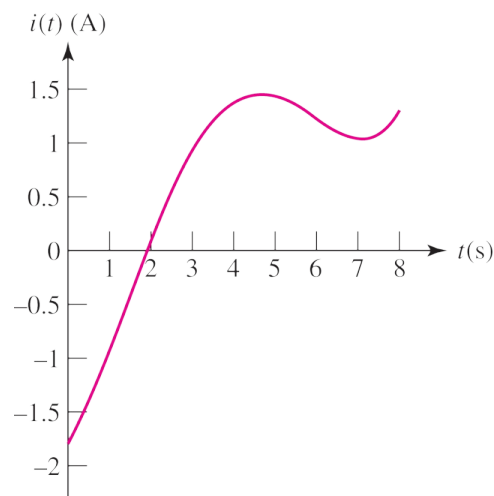

■ FIGURE 2.3 The instantaneous current $i = dq/dt$, where q is given in [Fig. 2.2](#).



Note that a current represented by i or $i(t)$ can be constant (dc) or time-varying, but currents represented by the symbol I must be non-time-varying.

The total charge transferred over all time is thus given by

$$q(t) = \int_{t_0}^t i dt' + q(t_0) \quad [3]$$

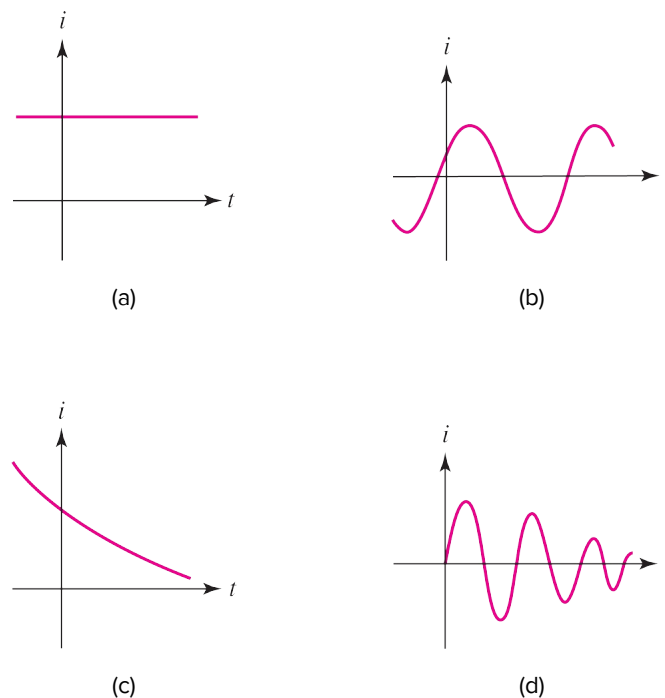

Several different types of current are illustrated in [Fig. 2.4](#). A current that is constant in time is termed a direct current, or simply dc, and is shown by [Fig. 2.4a](#). We will find many practical examples of currents that vary sinusoidally with time ([Fig. 2.4b](#)); currents of this form are present in normal household circuits. Such a current is often referred to as alternating current, or ac. Exponential currents and damped sinusoidal currents ([Fig. 2.4c](#) and [Fig. 2.4d](#)) will also be encountered later.



■ FIGURE 2.4 Several types of current: (a) Direct current (dc). (b) Sinusoidal current (ac). (c) Exponential current. (d) Damped sinusoidal current.



Current is the flow of charge flowing through a wire or circuit component. We define the current path with an arrow, or flow of charge into or out of the wire or circuit component.

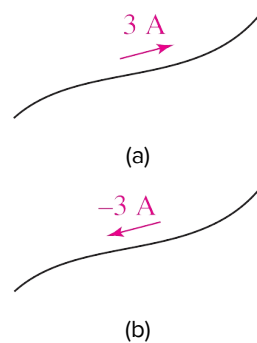

We create a graphical symbol for current by placing an arrow next to the conductor. Thus, in  **Fig. 2.5a** the direction of the arrow and the value 3 A indicate either that a net positive charge of 3 C/s is moving to the right or that a net negative charge of -3 C/s is moving to the left each second. In  **Fig. 2.5b** there are again two possibilities: either -3 A is flowing to the left or $+3$ A is flowing to the right. All four statements and both figures represent currents that are equivalent in their electrical effects, and we say that they are equal. A nonelectrical analogy that may be easier to visualize is to think in terms of a personal savings account: e.g., a deposit can be viewed as either a *negative* cash flow *out* of your account or a *positive* flow *into* your account.



■ FIGURE 2.5 Two methods of representation for the exact same current.

It is convenient to think of current as the motion of positive charge, even though it is known that current flow in metallic conductors results from electron motion. In ionized gases, in electrolytic solutions, and in some semiconductor materials, however, positive charges in motion constitute part or all of the current. Thus, any definition of current can agree with the physical nature of conduction only part of the time. The definition and symbolism we have adopted are standard.



It is essential that we realize that the current arrow does not indicate the “actual” direction of current flow but is simply part of a convention that allows us to talk about “the current in the wire” in an unambiguous manner. The arrow is a fundamental part of the definition of a current! Thus, to talk about the value of a current $i_1(t)$ without specifying the arrow is to discuss an undefined entity. For example,  **Fig. 2.6a** and  **b** are

meaningless representations of $i_1(t)$, whereas  Fig. 2.6c is complete.

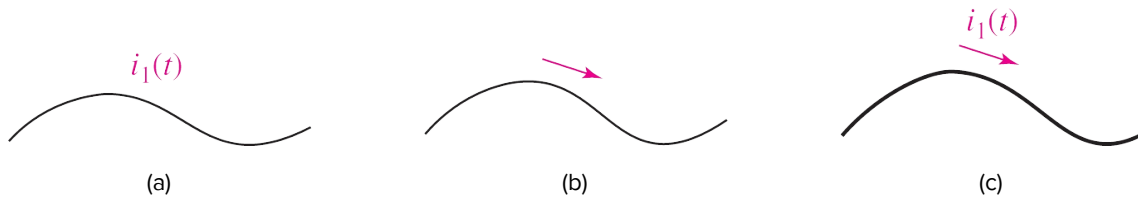

■ FIGURE 2.6 (a, b) Incomplete, improper, and incorrect definitions of a current. (c) The correct definition of $i_1(t)$.

PRACTICE

2.4 In the wire of  Fig. 2.7, electrons are moving *left to right* to create a current of 1 mA. Determine I_1 and I_2 .

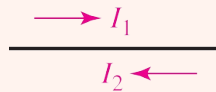

■ FIGURE 2.7

▼ Ans

$$I_1 = -1 \text{ mA}; I_2 = +1 \text{ mA}.$$

Voltage

We must now begin to refer to a circuit element, something best defined in general terms to begin with. Such electrical devices as fuses, light bulbs, resistors, batteries, capacitors, generators, and spark coils can be represented by combinations of simple circuit elements. We begin by showing a very general circuit element as a shapeless object possessing two terminals at which connections to other elements may be made ( Fig. 2.8).

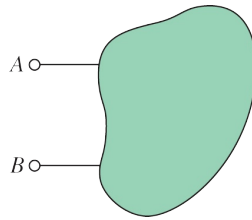

■ FIGURE 2.8 A general two-terminal circuit element.

There are two paths by which current may enter or leave the element. In subsequent discussions we will define particular circuit elements by describing the electrical characteristics that may be observed at their terminals.

In [Fig. 2.8](#), let us suppose that a dc current is sent into terminal A , through the general element, and back out of terminal B . Let us also assume that pushing charge through the element requires an expenditure of energy. We then say that an electrical voltage (or a *potential difference*) exists between the two terminals, or that there is a voltage “across” the element. Thus, the voltage across a terminal pair is a measure of the work required to move charge through the element. The unit of voltage is the *volt*,⁴ and 1 volt is the same as 1 J/C. Voltage is represented by V or v .

A voltage can exist between a pair of electrical terminals whether a current is flowing or not. An automobile battery, for example, has a voltage of 12 V across its terminals even if nothing whatsoever is connected to the terminals.

According to the principle of conservation of energy, the energy that is expended in forcing charge through the element must appear somewhere else. When we later meet specific circuit elements, we will note whether that energy is stored in some form that is readily available as electric energy or whether it changes irreversibly into heat, light, or some other nonelectrical form of energy.

We must now establish a convention by which we can distinguish between energy supplied *to* an element and energy that is supplied *by* the element itself. We do this by our choice of sign for the voltage of terminal A with respect to terminal B . If a positive current is entering terminal A of the element and an external source must expend energy to establish this current, then terminal A

is positive with respect to terminal B . (Alternatively, we may say that terminal B is negative with respect to terminal A .)

The sense of the voltage is indicated by a plus-minus pair of algebraic signs. In [Fig. 2.9a](#), for example, the placement of the $+$ sign at terminal A indicates that terminal A is v volts positive with respect to terminal B . If we later find that v happens to have a numerical value of -5 V , then we may say either that A is -5 V positive with respect to B or that B is 5 V positive with respect to A . Other cases are shown in [Fig. 2.9b](#), [c](#), and [d](#).

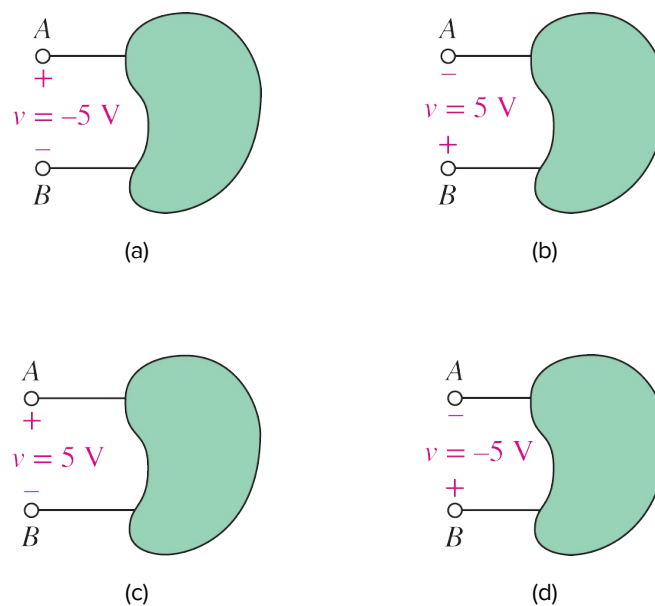



■ FIGURE 2.9 (a, b) Terminal B is 5 V positive with respect to terminal A; (c, d) terminal A is 5 V positive with respect to terminal B.



Voltage is the electric potential difference across two terminals of a circuit component. We define the voltage across two terminals with labeled plus-minus signs.

Just as we noted in our definition of current, it is essential to realize that the plus-minus pair of algebraic signs does not indicate the “actual” polarity of the voltage but is simply part of a convention that enables us to talk unambiguously about “the voltage across the terminal pair.” *The definition of*

any voltage must include a plus-minus sign pair! Using a quantity $v_1(t)$ without specifying the location of the plus-minus sign pair is using an undefined term.  **Figure 2.10a** and  **b** do *not* serve as definitions of $v_1(t)$;  **Fig. 2.10c** does.

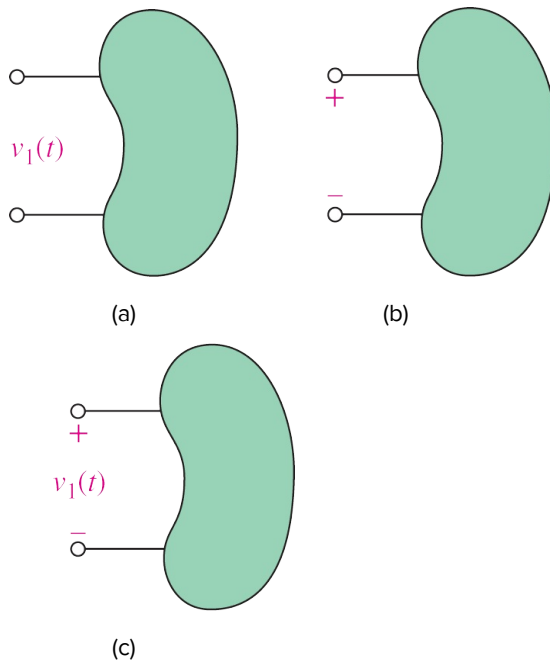

■ FIGURE 2.10 (a, b) These are inadequate definitions of a voltage. (c) A correct definition includes both a symbol for the variable and a plus-minus symbol pair.



PRACTICE

2.5 For the element in  **Fig. 2.11**, if $v_1 = 17 \text{ V}$, determine v_2 .

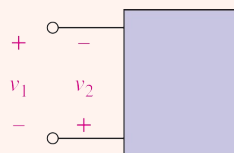

■ FIGURE 2.11

▼ Ans

$$v_2 = -17 \text{ V.}$$

Power

We have already defined power, and we will represent it by P or p . If one joule of energy is expended in transferring one coulomb of charge through the device in one second, then the rate of energy transfer is one watt. The absorbed power must be proportional both to the number of coulombs transferred per second (current) and to the energy needed to transfer one coulomb through the element (voltage). Thus,

$$p = vi \quad [4]$$

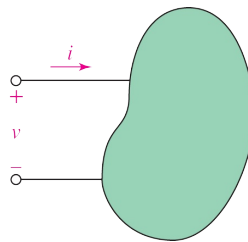

Dimensionally, the right side of this equation is the product of joules per coulomb and coulombs per second, which produces the expected dimension of joules per second, or watts. The conventions for current, voltage, and power are shown in  Fig. 2.12.









■ FIGURE 2.12 The power absorbed by the element is given by the product $p = vi$. Alternatively, we can say that the element generates or supplies a power $-vi$.



We now have an expression for the power being absorbed by a circuit element in terms of a voltage across it and current through it. Voltage was defined in terms of an energy expenditure, and power is the rate at which energy is expended. However, no statement can be made concerning energy transfer in



any of the four cases shown in  Fig. 2.9, for example, until the direction of the current is specified. Let us imagine that a current arrow is placed alongside each upper lead, directed to the right, and labeled “+2 A.” First, consider the case shown in  Fig. 2.9c. Terminal A is 5 V positive with respect to terminal B , which means that 5 J of energy is required to move each coulomb of positive charge into terminal A , through the object, and out terminal B . Since we are injecting +2 A (a current of 2 coulombs of positive charge per second) into terminal A , we are doing $(5 \text{ J/C}) \times (2 \text{ C/s}) = 10 \text{ J}$ of work per second on the object. In other words, the object is absorbing 10 W of power from whatever is injecting the current.

We know from an earlier discussion that there is no difference between  Fig. 2.9c and  d, so we expect the object depicted in  Fig. 2.9d to also be absorbing 10 W. We can check this easily enough: we are injecting +2 A into terminal A of the object, so +2 A flows out of terminal B . Another way of saying this is that we are injecting -2 A of current into terminal B . It takes -5 J/C to move charge from terminal B to terminal A , so the object is absorbing $(-5 \text{ J/C}) \times (-2 \text{ C/s}) = +10 \text{ W}$ as expected. The only difficulty in describing this particular case is keeping the minus signs straight, but with a bit of care we see the correct answer can be obtained regardless of our choice of positive reference terminal (terminal A in  Fig. 2.9c, and terminal B in  Fig. 2.9d).

Now let's look at the situation depicted in  Fig. 2.9a, again with Page 16
+2 A injected into terminal A . Since it takes -5 J/C to move charge from terminal A to terminal B , the object is absorbing $(-5 \text{ J/C}) \times (2 \text{ C/s}) = -10 \text{ W}$. What does this mean? How can anything absorb *negative* power? If we think about this in terms of energy transfer, -10 J is transferred to the object each second through the 2 A current flowing into terminal A . The object is actually losing energy—at a rate of 10 J/s. In other words, it is supplying 10 J/s (i.e., 10 W) to some other object not shown in the figure. Negative *absorbed* power, then, is equivalent to positive *supplied* power.

If the current arrow is directed into the “+” marked terminal of an element, then $p = vi$ yields the absorbed power. A negative value indicates that power is actually being generated by the element.

If the current arrow is directed out of the “+” terminal of an element, then $p = vi$ yields the supplied power. A negative value in this case indicates that power is being absorbed.

Let’s recap.  **Figure 2.12** shows that if one terminal of the element is v volts positive with respect to the other terminal, and if a current i is entering the element through that terminal, then a power $p = vi$ is being *absorbed* by the element; it is also correct to say that a power $p = vi$ is being *delivered* to the element. When the current arrow is directed into the element at the plus-marked terminal, we satisfy the *passive sign convention*. This convention should be studied carefully, understood, and memorized. In other words, it says that if the current arrow and the voltage polarity signs are placed such that the current enters the terminal on the element marked with the positive sign, then the power *absorbed* by the element can be expressed by the product of the specified current and voltage variables. If the numerical value of the product is negative, then we say that the element is absorbing negative power, or that it is actually generating power and delivering it to some external element. For example, in  **Fig. 2.12** with $v = 5 \text{ V}$ and $i = -4 \text{ A}$, the element may be described as either absorbing -20 W or generating 20 W .

Conventions are only required when there is more than one way to do something, and confusion may result when two different groups try to communicate. For example, it is rather arbitrary to always place “North” at the top of a map; compass needles don’t point “up,” anyway. Still, if we were talking to people who had (unknown to us) chosen the opposite convention of placing “South” at the top of their maps, imagine the confusion that could result! In the same fashion, there is a general convention that always draws the current arrows pointing into the positive voltage terminal, regardless of whether the element supplies or absorbs power. This convention is not incorrect but sometimes results in counterintuitive currents labeled on circuit

schematics. The reason for this is that it simply seems more natural to refer to positive current flowing out of a voltage or current source that is supplying positive power to one or more circuit elements.

EXAMPLE 2.1

Compute the power absorbed by each part in  Fig. 2.13.

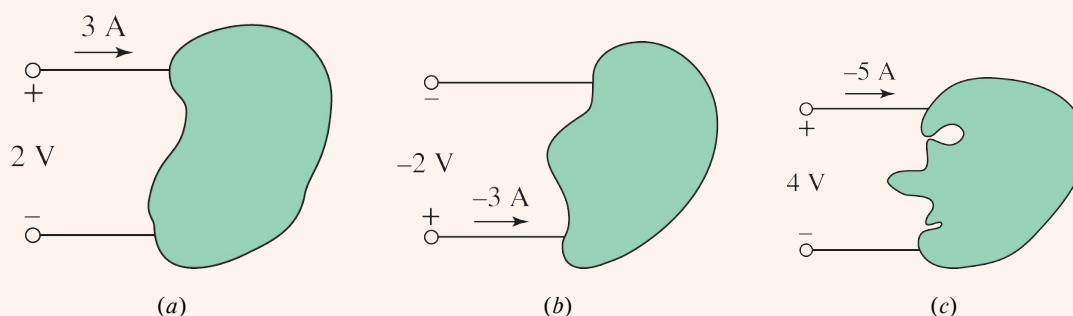

■ FIGURE 2.13 (a, b, c) Three examples of two-terminal elements.



In  Fig. 2.13a, we see that the reference current is defined consistent with the passive sign convention, which assumes that the element is absorbing power. With $+3 \text{ A}$ flowing into the positive reference terminal, we compute

$$P = (2 \text{ V})(3 \text{ A}) = 6 \text{ W}$$

of power absorbed by the element.

 Figure 2.13b shows a slightly different picture. Now, we have a current of -3 A flowing into the positive reference terminal. This gives us an absorbed power

$$P = (-2 \text{ V})(-3 \text{ A}) = 6 \text{ W}$$

Thus, we see that the two cases are actually equivalent: A current of **+3 A** flowing into the top terminal is the same as a current of **+3 A** flowing out of the bottom terminal, or, equivalently, a current of **-3 A** flowing into the bottom terminal.

Referring to  **Fig. 2.13c**, we again apply the passive sign convention rules and compute an absorbed power

$$P = (4 \text{ V})(-5 \text{ A}) = -20 \text{ W}$$

Since we computed a negative *absorbed* power, this tells us that the element in  **Fig. 2.13c** is actually *supplying* **+20 W** (i.e., it's a source of energy).

PRACTICE

2.6 Determine the power being absorbed by the circuit element in  **Fig. 2.14a**.

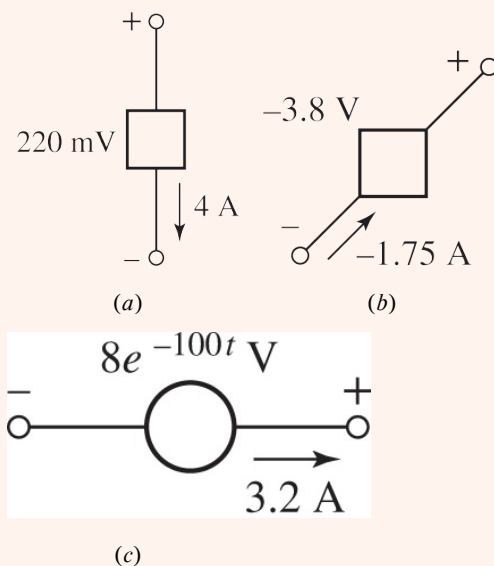

■ FIGURE 2.14



▼ Ans

880 mW

2.7 Determine the power being supplied by the circuit element in  **Fig. 2.14b**.

▼ Ans

6.65 W

2.8 Determine the power being delivered to the circuit element in  **Fig. 2.14c** at $t = 5 \text{ ms}$.

▼ Ans

−15.53 W

Energy

In electrical circuits, attention is often devoted to power, but sometimes we would also like to know the total energy transferred for a given period of time. For example, energy usage determines how long the battery in your circuit will last, or what your electricity bill will be. Recalling that power is the rate of work, energy (w) is defined as

$$w(t) = \int_{t_0}^t p \, dt' = \int_{t_0}^t vi \, dt' \quad [5]$$

The SI unit of energy is the *joule* (J). Noting that energy is the product of power and time (**1 joule = 1 watt × 1 second**), it is also convenient

to define energy in terms of *watt hours* (Wh) or *kilowatt hours* (kWh). Electrical utilities typically charge electricity usage in units of kWh, and this unit is typically displayed on the dashboard or display of electric vehicles. Converting units yields the relations

$$1 \text{ Wh} = 3600 \text{ J} \quad [6]$$

$$1 \text{ kWh} = 3.6 \times 10^6 \text{ J} \quad [7]$$

Battery capacity (energy stored) can also be defined in terms of Wh. Since the voltage on a battery is constant, it becomes convenient to separate out the battery voltage and simply refer to the total charge storage on the battery (Q). Thus,

$$w = \int vi \, dt = V \int i \, dt = VQ \quad [8]$$

The total charge Q is given in units of *amp hours* (Ah) or *milliamp hours* (mAh)

$$1 \text{ Ah} = 3600 \text{ C} \quad [9]$$

$$1 \text{ mAh} = 3.6 \text{ C} \quad [10]$$

EXAMPLE 2.2

A battery-powered smoke detector has an average power consumption of 0.5 mW and runs off of a 9 V battery with a capacity of 500 mAh. How often do you expect to change the battery?

The battery will need to be changed when the total energy consumed by the smoke detector has reached the total energy stored in the battery. The energy consumed by the smoke detector is

$$w = (0.5 \text{ mW})(t)$$

and the total energy stored in the battery is given by

$$w = (0.5 \text{ Ah})(9 \text{ V})$$

Equating the two after converting units, and solving for t results in

$$t = \frac{(0.5 \text{ Ah})(9 \text{ V})}{(0.5 \times 10^{-3} \text{ W})} = 9000 \text{ h}$$

$$t = 9000 \text{ h} \times \frac{(1 \text{ day})}{(24 \text{ h})} \times \frac{(1 \text{ year})}{(365 \text{ days})} = 1.03 \text{ years}$$

(Note that every 6 months is a standard recommendation, for safety.)

PRACTICE

2.9 A certain rechargeable smartphone battery has a voltage of 3.8 V and capacity of 1800 mAh. You find that a single battery charge can provide 12 h of talk time, or 10 days of standby time. What is the average power consumption for (a) talk mode and (b) standby mode?

► Ans

2.3 VOLTAGE AND CURRENT SOURCES

Using the concepts of current and voltage, it is now possible to be more specific in defining a *circuit element*.

In so doing, it is important to differentiate between the physical device itself and the mathematical model that we will use to analyze its behavior in a circuit. The model is only an approximation.

We will use the expression *circuit element* to refer to the mathematical model. The choice of a particular model for any real device must be made on the basis of experimental data or experience; we will usually assume that this choice has already been made. For simplicity, we initially consider circuits with idealized components represented by simple models.

By definition, a simple circuit element is the mathematical model of a two-terminal electrical device, and it can be completely characterized by its voltage–current relationship; it cannot be subdivided into other two-terminal devices.

All of the simple circuit elements we will consider can be classified according to the relationship of the current through the element to the voltage across the element. For example, if the voltage across the element is linearly proportional to the current through it, we will call the element a resistor. Other types of simple circuit elements have terminal voltages which are proportional to the *derivative* of the current with respect to time (an inductor), or to the *integral* of the current with respect to time (a capacitor). There are also elements in which the voltage is completely independent of the current, or the current is completely independent of the voltage; these are termed *independent sources*. Furthermore, we will need to define special kinds of sources for which either the source voltage or current depends upon a current or voltage elsewhere in the circuit; such sources are referred to as *dependent sources*. Dependent

sources are used a great deal in electronics to model both dc and ac behavior of transistors, especially in amplifier circuits.

Independent Voltage Sources

The first element we will consider is the *independent voltage source*. The circuit symbol is shown in  Fig. 2.15a; the subscript s merely identifies the voltage as a “source” voltage, and is common but not required. *An independent voltage source is characterized by a terminal voltage which is completely independent of the current through it.* Thus, if we are given an independent voltage source and are notified that the terminal voltage is 12 V, then we always assume this voltage, regardless of the current flowing.

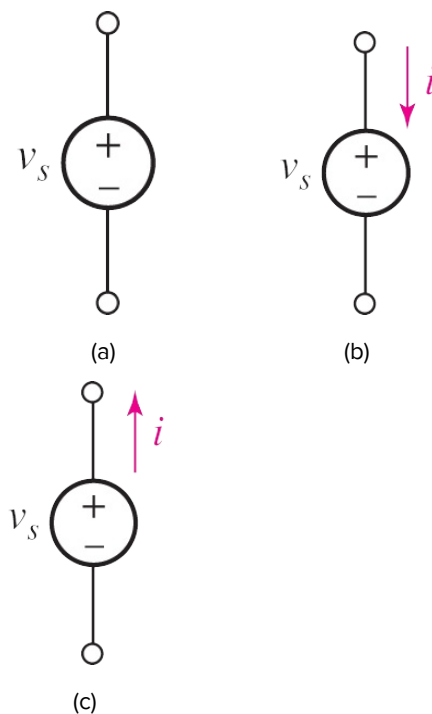



■ FIGURE 2.15 Circuit symbol of the independent voltage source.

If you've ever noticed the room lights dim when an air conditioner kicks on, it's because the sudden large current demand temporarily led to a (nonideal) voltage drop. After the motor starts moving, it takes less current to keep it in motion. At that point, the current demand is

reduced, the voltage returns to its original value, and the wall outlet again provides a reasonable approximation of an ideal voltage source.

The independent voltage source is an *ideal* source and does not represent exactly any real physical device, because the ideal source could theoretically deliver an infinite amount of energy from its terminals. This idealized voltage source does, however, furnish a reasonable approximation to several practical voltage sources. An internal combustion engine (ICE) automobile storage battery, for example, has a 12 V terminal voltage that remains essentially constant as long as the current through it does not exceed a few amperes. A small current may flow in either direction through the battery. If it is positive and flowing out of the positively marked terminal, then the battery is furnishing power to the headlights, for example; if the current is positive and flowing into the positive terminal, then the battery is charging by absorbing energy from the alternator.⁵ An ordinary Canadian or U.S. household electrical outlet also approximates an independent voltage source, providing a voltage $v_s = 120\sqrt{2} \cos 2\pi 60t$ V; this representation is valid for currents less than 20 A or so.

A point worth repeating here is that the presence of the plus sign at the upper end of the symbol for the independent voltage source in  Fig. 2.15a does not necessarily mean that the upper terminal is numerically positive with respect to the lower terminal. Instead, it means that the upper terminal is v_s volts positive with respect to the lower terminal. If at some instant v_s happens to be negative, then the upper terminal is actually negative with respect to the lower terminal at that instant.

Consider a current arrow labeled “ i ” placed adjacent to the upper conductor of the source as in  Fig. 2.15b. The current i is entering the terminal at which the positive sign is located, the passive sign convention is satisfied, and the source thus *absorbs* power $p = v_s i$. More often than not, a source is expected to deliver power to a network and not to absorb it. Consequently, we might choose to direct the arrow as in  Fig. 2.15c so that $v_s i$ will represent the power *delivered* by the source. Technically, either arrow direction may be

chosen; whenever possible, we will adopt the convention of [Fig. 2.15c](#) in this text for voltage and current sources, which are not usually considered passive devices.

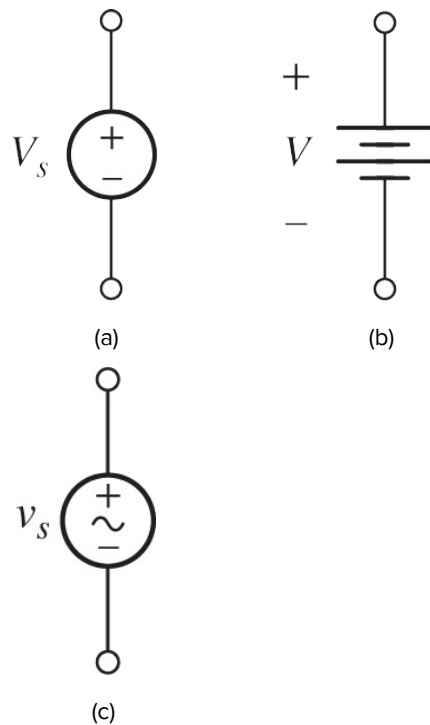

Terms like dc voltage source and dc current source are commonly used. Literally, they mean “direct-current voltage source” and “direct-current current source,” respectively. Although these terms may seem a little odd or even redundant, the terminology is so widely used there’s no point in fighting it.

An independent voltage source with a constant terminal voltage is often termed an independent dc voltage source and can be represented by either of the symbols shown in [Fig. 2.16a](#) and [Fig. 2.16b](#). Note in [Fig. 2.16b](#) that when the physical plate structure of the battery is suggested, the longer plate is placed at the positive terminal; the plus and minus signs then represent redundant notation, but they are usually included anyway. For the sake of completeness, the symbol for an independent ac voltage source is shown in [Fig. 2.16c](#).



■ FIGURE 2.16 (a) DC voltage source symbol; (b) battery symbol; (c) ac voltage source symbol.

Independent Current Sources

Another ideal source which we will need is the *independent current source*. Here, the current through the element is completely independent of the voltage across it. The symbol for an independent current source is shown in  **Fig. 2.17**. If i_s is constant, we call the source an independent dc current source. An ac current source is often drawn with a tilde through the arrow, similar to the ac voltage source shown in  **Fig. 2.16c**.

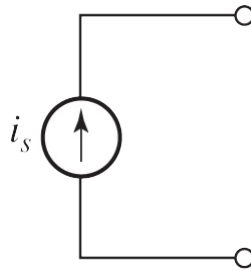

■ FIGURE 2.17 Circuit symbol for the independent current source.

Like the independent voltage source, the independent current source is at best a reasonable approximation for a physical element. In theory it can deliver infinite power from its terminals because it produces the same finite current for any voltage across it, no matter how large that voltage may be. It is, however, a good approximation for many practical sources, particularly in electronic circuits.



Although most students seem happy enough with an independent voltage source providing a fixed voltage but essentially any current, *it is a common mistake* to view an independent current source as having zero voltage across its terminals while providing a fixed current. In fact, we do not know a priori what the voltage across a current source will be—it depends entirely on the circuit to which it is connected.

Dependent Sources

The two types of ideal sources that we have discussed up to now are called

independent sources because the value of the source quantity is not affected in any way by activities in the remainder of the circuit. This is in contrast with yet another kind of ideal source, the *dependent*, or *controlled*, source, in which the source quantity is determined by a voltage or current existing at some other location in the system being analyzed. Sources such as these appear in the equivalent electrical models for many electronic devices, such as transistors, operational amplifiers, and integrated circuits. To distinguish between dependent and independent sources, we introduce the diamond symbols shown in Fig. 2.18. In Fig. 2.18a and c, K is a dimensionless scaling constant. In Fig. 2.18b, g is a scaling factor with units of A/V; in Fig. 2.18d, r is a scaling factor with units of V/A. The controlling current i_x and the controlling voltage v_x must be defined somewhere in the circuit.

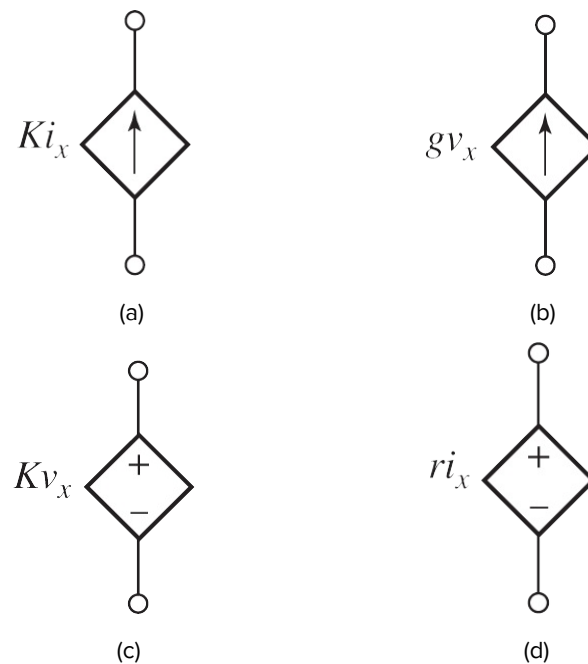

■ FIGURE 2.18 The four different types of dependent sources: (a) current-controlled current source; (b) voltage-controlled current source; (c) voltage-controlled voltage source; (d) current-controlled voltage source.

It does seem odd at first to have a current source whose value depends on a

voltage, or a voltage source which is controlled by a current flowing through some other element. Even a voltage source depending on a remote voltage can appear strange. Such sources are invaluable for modeling complex systems, however, making the analysis algebraically straightforward. Examples include the drain current of a field effect transistor as a function of the gate voltage, or the output voltage of an analog integrated circuit as a function of differential input voltage. When encountered during circuit analysis, we write down the entire controlling expression for the dependent source just as we would if it was a numerical value attached to an independent source. This often results in the need for an additional equation to complete the analysis, unless the controlling voltage or current is already one of the specified unknowns in our system of equations.

EXAMPLE 2.3

In the circuit of  Fig. 2.19a, determine v_L if v_2 is 3 V.

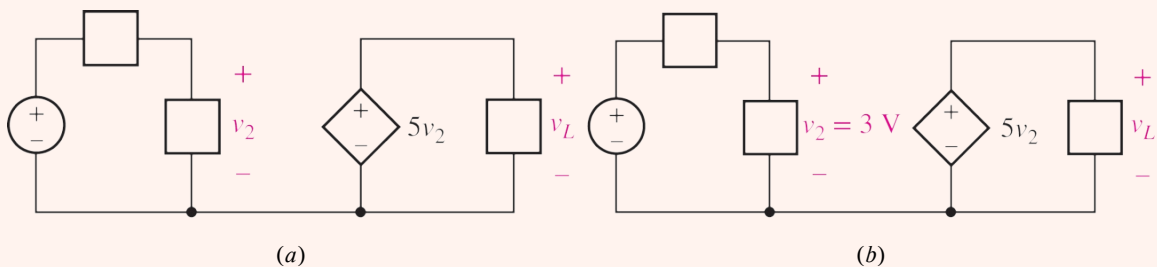

■ FIGURE 2.19 (a) An example circuit containing a voltage-controlled voltage source. (b) The additional information provided is included on the diagram.



▶ **Identify the goal of the problem.**

We need to determine the voltage across the far-right element using the pre-assigned polarity.

▶ **Collect the known information.**

We have been provided with a partially labeled circuit diagram. We should add the additional information that $v_2 = 3 \text{ V}$ to the

schematic ( Fig. 2.19b).

▶ **Devise a plan.**

We notice that the desired voltage is the same as the voltage across the dependent voltage source. If we find that voltage, we have our answer.

▶ **Construct an appropriate set of equations.**

We write

$$v_L = 5v_2$$

and

$$v_2 = 3$$

Thus, we have two equations in two unknowns.

▶ **Determine if additional information is required.**

We have two equations in two variables (v_L and v_2). This is sufficient to solve.

▶ **Attempt a solution.**

This simple set of equations is easily solved to determine that $v_L = 15 \text{ V}$. We see that the time it takes to completely label a circuit diagram is a good investment!

▶ **Verify the solution. Is it reasonable or expected?**

We can (and should) go back and check our math. We have limited information about the circuit so our expectations might be equally limited. Still, we note a controlling voltage of 3 V and a voltage elsewhere of 15 V . These are within an order of magnitude of each other, which is a good indication (i.e., one of them is not 1,000,000 times the other).

PRACTICE

2.10 Find the power *absorbed* by each element in the circuit in

 Fig. 2.20.

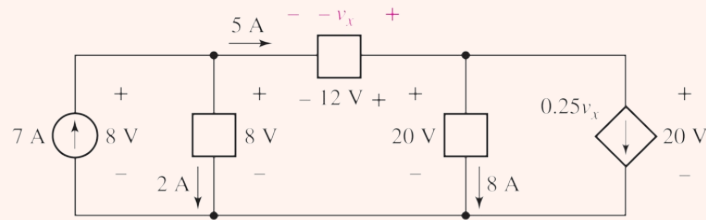

■ FIGURE 2.20



▼ Ans

(left to right) -56 W ; 16 W ; -60 W ; 160 W ; -60 W .

Dependent and independent voltage and current sources are *active* elements; they are capable of delivering power to some external device. For the present we will think of a *passive* element as one which is capable only of receiving power. However, we will later see that several passive elements are able to store finite amounts of energy and then return that energy later to various external devices; since we still wish to call such elements passive, it will be necessary to improve upon our two definitions a little later.

Networks and Circuits

The interconnection of two or more simple circuit elements forms an electrical *network*. If the network contains at least one closed path, it is also an electric *circuit*. Note: Every circuit is a network, but not all networks are circuits (see  Fig. 2.21)!

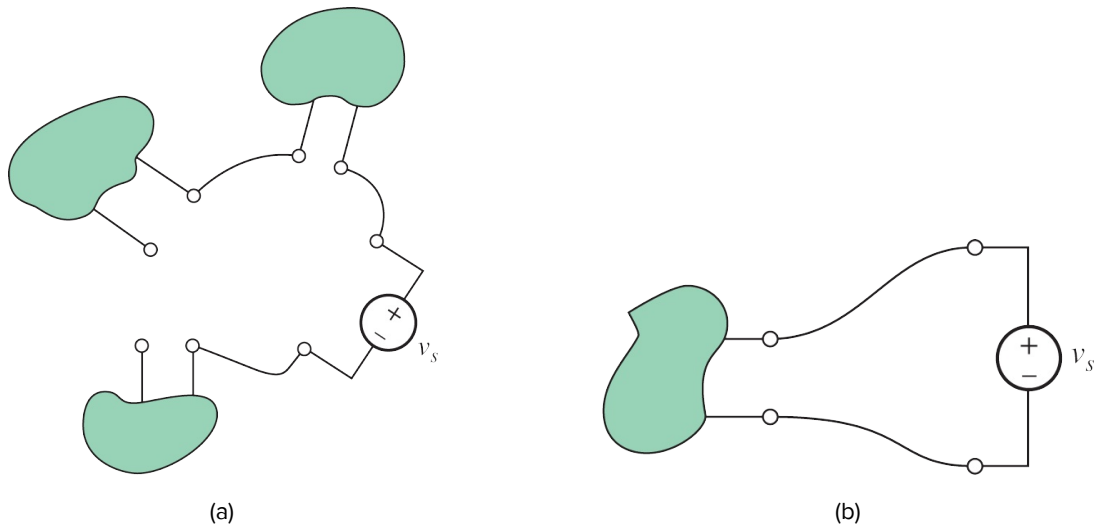



■ FIGURE 2.21 (a) A network that is not a circuit. (b) A network that is a circuit.



A network that contains at least one active element, such as an independent voltage or current source, is an active network. A network that does not contain any active elements is a passive network.

We have now defined what we mean by the term *circuit element*, and we have presented the definitions of several specific circuit elements, the independent and dependent voltage and current sources. Throughout the remainder of the book we will define only five additional circuit elements: the resistor, inductor, capacitor, transformer, and the ideal operational amplifier (“op amp,” for short). These are all ideal elements. They are important because we may combine them into networks and circuits that represent real devices as accurately as we require. Thus, the transistor shown in

 **Fig. 2.22a** and  **b** may be modeled by the voltage terminals designated v_{gs} and the single dependent current source of  **Fig. 2.22c**. Note that the dependent current source produces a current that depends on a voltage elsewhere in the circuit. The parameter g_m , commonly referred to as the transconductance, is calculated using transistor-specific details as well as the operating point determined by the circuit connected to the transistor. It is generally a small number, on the order of 10^{-2} to perhaps 10 A/V. This

model works pretty well as long as the frequency of any sinusoidal source is neither very large nor very small; the model can be modified to account for frequency-dependent effects by including additional ideal circuit elements.

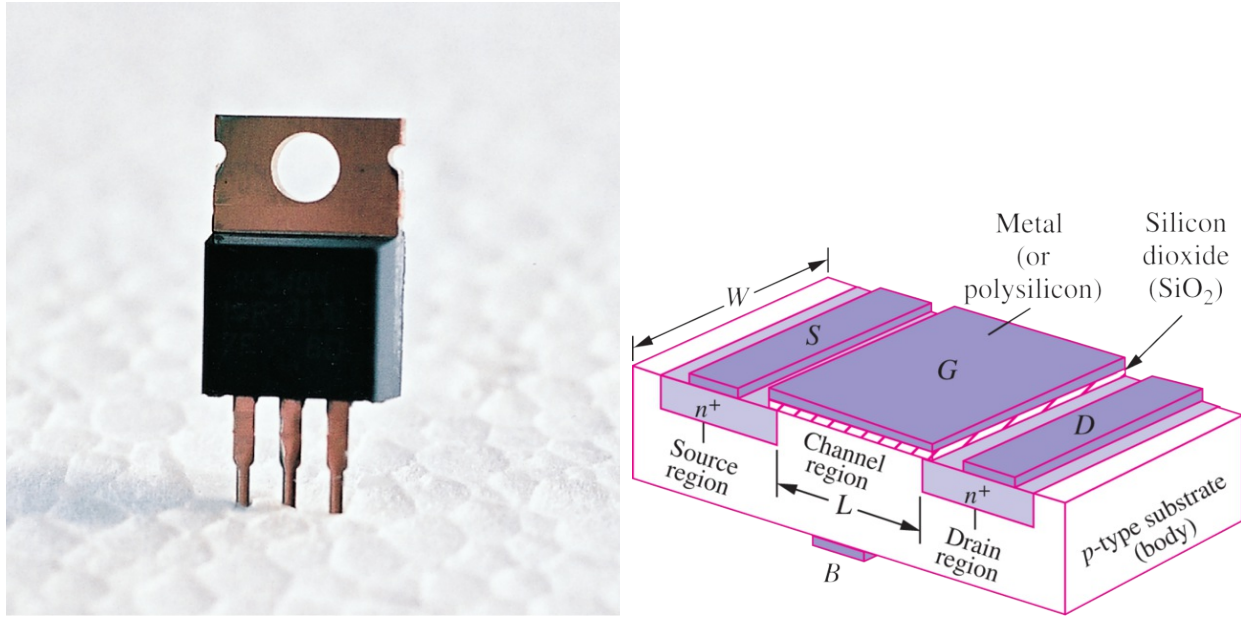

(a)

(b)

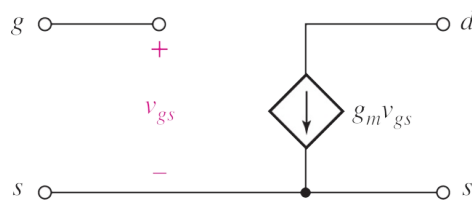

(c)

■ FIGURE 2.22 The metal oxide semiconductor field effect transistor (MOSFET). (a) An IRF540 N-channel power MOSFET in a TO-220 package, rated at 100 V and 22 A; (b) cross-sectional view of a basic MOSFET; (c) equivalent circuit model for use in ac circuit analysis.

(a) Steve Durbin/McGraw Hill (b) R. Jaeger, *Microelectronic Circuit Design*, McGraw-Hill, 1997



Similar (but much smaller) transistors typically constitute only one small part of an integrated circuit that may be less than **2 mm × 2 mm** square and 200 μm thick and yet contain several thousand transistors plus various resistors and capacitors. Thus, we may have a physical device that is about the size of

one letter on this page but requires a model composed of ten thousand ideal simple circuit elements. We use this concept of “circuit modeling” in a number of electrical engineering topics covered in other courses, including electronics, energy conversion, and antennas.

2.4 OHM'S LAW

So far, we have been introduced to both dependent and independent voltage and current sources and were cautioned that they were *idealized* active elements that could only be approximated in a real circuit. We are now ready to meet another idealized element, the linear resistor. The resistor is the simplest passive element, and we begin our discussion by considering the work of an obscure German physicist, Georg Simon Ohm, who published a pamphlet in 1827 that described the results of one of the first efforts to measure currents and voltages, and to describe and relate them mathematically. One result was a statement of the fundamental relationship we now call *Ohm's law*, even though it has since been shown that this result was discovered 46 years earlier in England by Henry Cavendish, a brilliant semirecluse.

Ohm's law states that the voltage across conducting materials is directly proportional to the current flowing through the material, or

$$v = Ri \quad [11]$$

where the constant of proportionality R is called the *resistance*. The unit of resistance is the *ohm*, which is 1 V/A and customarily abbreviated by a capital omega, Ω .

When this equation is plotted on i -versus- v axes, the graph is a straight line passing through the origin ([Fig. 2.23](#)). [Equation \[4\]](#) is a linear equation, and we will consider it to be the definition of a *linear resistor*. Resistance is normally considered to be a positive quantity, although negative resistances may be simulated with special circuitry.

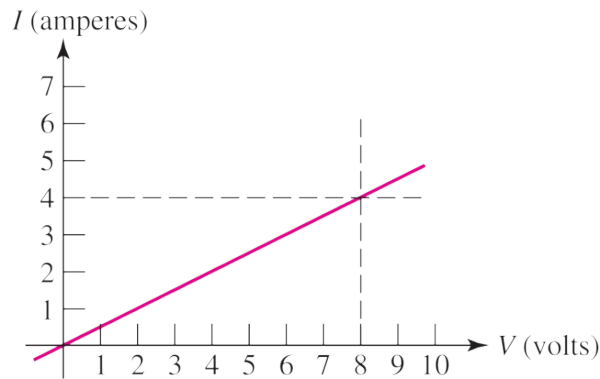

■ FIGURE 2.23 Current–voltage relationship for an example $2\ \Omega$ linear resistor. Note the slope of the line is $0.5\ \text{A/V}$, or $500\ \text{m}\Omega^{-1}$.



Again, it must be emphasized that the linear resistor is an idealized circuit element; it is only a mathematical model of a real, physical device. “Resistors” may be easily purchased or manufactured, but it is soon found that the voltage–current ratios of these physical devices are reasonably constant only within certain ranges of current, voltage, or power, and they also depend on temperature and other environmental factors. We usually refer to a linear resistor as simply a resistor; any resistor that is nonlinear should always be described as such.

Power Absorption

☞ **Figure 2.24** shows several different resistor packages, as well as the most common circuit symbol used for a resistor. In accordance with the voltage, current, and power conventions already adopted, the product of v and i gives the power absorbed by the resistor. That is, v and i are selected to satisfy the passive sign convention. The absorbed power appears physically as heat and/or light and is always positive; a resistor is a passive element that cannot deliver power or store energy. Alternative expressions for the absorbed power are

$$p = vi = i^2 R = v^2 / R \quad [12]$$

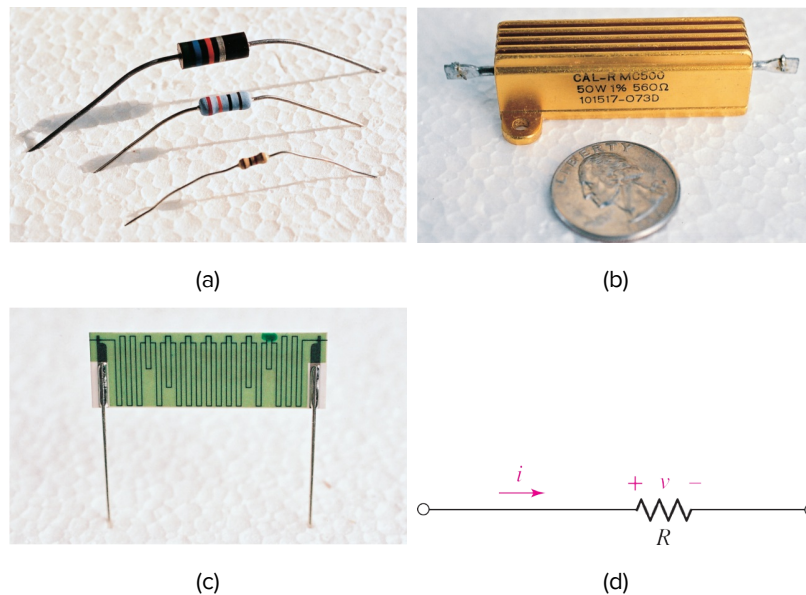

■ FIGURE 2.24 (a) Several common resistor packages. (b) A $560\ \Omega$ power resistor rated at up to 50 W. (c) A 5% tolerance 10-teraohm ($10,000,000,000,000\ \Omega$) resistor manufactured by Ohmcraft. (d) Circuit symbol for the resistor, applicable to all of the devices in (a) through (c). (a-c) Steve Durbin/McGraw Hill

One of the authors (who shall remain anonymous) had the unfortunate experience of inadvertently connecting a $100\ \Omega$, 2 W carbon resistor across a 110 V source. The ensuing flame, smoke, and fragmentation were rather disconcerting, demonstrating clearly that a practical resistor has definite limits to its ability to behave like the ideal linear model. In this case, the unfortunate resistor was called upon to absorb 121 W; since it was designed to handle only 2 W, its reaction was understandably violent.

EXAMPLE 2.4

The $560\ \Omega$ resistor shown in [Fig. 2.24b](#) is connected to a circuit which causes a current of 42.4 mA to flow through it. Calculate the voltage across the resistor and the power it is dissipating.